

RD0348

Single 14" Jumbo Stainless Steel Tissue Dispenser



FEATURES

- Design offers simplistic & modern appeal
- Window allows for easy view of paper supply
- Cover & back are hinged together, making it one piece
- Holds up to a 14" roll with a 2-1/4" core
- Works with cores as small as 1-3/4"

AVAILABLE COLORS

Brushed Stainless



White



SPECIFICATIONS

Model #	RD0348-09 (Brushed Stainless) RD0348-17 (White)		
Dimensions	14.09"W x 14.25"H x 4.65"D		
Weight	4.05 lbs	Case Pack	6 per case - 4.25' ³
Capacity	14" Roll (1 3/4"-2 1/4" Core)	Key Type	13

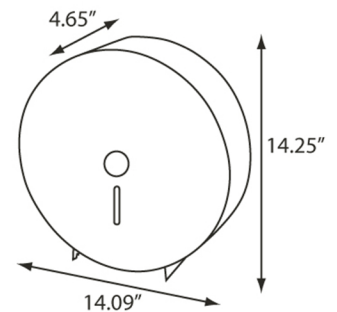

Ph: 800.558.8678
Ph: 920.884.8698
Fax: 920.884.8699
info@palmerfixture.com



Palmer Fixture
P.O. Box 10887
Green Bay, WI 54307
www.palmerfixture.com