

## LED VOLUMETRIC TROFFER

### SELECTABLE OUTPUT SERIES

#### DESCRIPTION

Combining top-of-the-line efficiency, versatility, and a stylish, modern design, our line of LED Volumetric Troffers offers ideal solutions for a wide range of interior applications.

Our Selectable Output Series features field-selectable wattage and CCT, enabling a wide range of output options from a single fixture. Each fixture includes up to 5 unique lumen levels and 3 options for color temperature (3500/4000/5000). Also, each wattage is individually qualified with the DLC to ensure the best rebates based on the actual energy usage.

Installation is simple and quick; this LED troffer upgrade fits seamlessly into all standard 2' x 4', 2' x 2' or 1' x 4' grid ceiling layouts. It can also be recessed into drywall ceiling applications, surface mounted or suspension mounted as alternatives.

The LED Volumetric Troffer delivers up to 125 lumens per watt (LPW) over the course of its 100,000-hour rated life. It ensures long-term energy savings over traditional fluorescent bulbs and ballasts, as well as eliminates routine maintenance, making it perfect for updating existing grid layouts or implementing in new construction. Furthermore, it's backed by an industry-leading 10-year warranty, guaranteeing peace of mind for the life of your fixture.

#### FEATURES

- Selectable wattage (5 settings)
- Selectable CCT (3500K, 4000K, 5000K)
- DLC Premium (up to 125 LPW)
- Size options: 2x4, 2x2, 1x4
- UL Damp location rating
- IC rated
- 0-10V Dimming
- 100,000-hour rated life
- 10-year warranty
- Compatible with Emergency Battery Backup
- Easy installation
- Grid, suspension, surface or recessed mounting



#### MARKETS

- Schools and universities
- Offices and municipal buildings
- Healthcare facilities and hospitals

#### MOUNTING

- Grid ceiling
- Suspension
- Surface Mount
- Recessed drywall

#### CERTIFICATIONS



## SPECIFICATIONS

**Average rated life:** 100,000 hours (@L70)  
**Warranty:** 10 years  
**Operating temp:** -4°F to 113°F (-20°C to 45°C)  
**Surge protection:** ANSI C82.77 compliant  
**Input voltage:** 120-277V  
**Input frequency:** 50/60Hz  
**Power factor:** ≥0.95  
**CRI:** 80  
**Diffuser type:** Polycarbonate frosted  
**Dimming:** 0-10VDC ANSI C137.x compliant

**Minimum dimming:** 0% of rated lumen LED drive current  
**Location rating:** Damp  
**UL listed:** Yes  
**RoHS compliant:** Yes  
**DLC rating:** Premium  
**IC rated:** Yes  
**IP rating:** 20

## MOUNTING

**Standard:** T-bar grid (drop ceilings)  
**Wiring access:** 1/2" trade size knockouts

## ACCESSORIES

**Emergency Battery Backup**  
**Surface Mounting Kit**  
**Drywall Mounting Kit**  
**Suspension Mounting Kit**

## DIMENSIONS

SIZE	LENGTH	WIDTH	HEIGHT
2' x 4'	47.75"	23.75"	2.875"
2' x 2'	23.75"	23.75"	2.875"
1' x 4'	47.75"	11.9"	2.875"

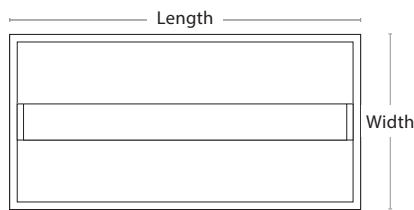

Panel (2' x 4' shown here)

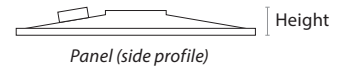

## PRODUCT OVERVIEW AND INSTALLATION

### STANDARD GRID CEILING MOUNTING

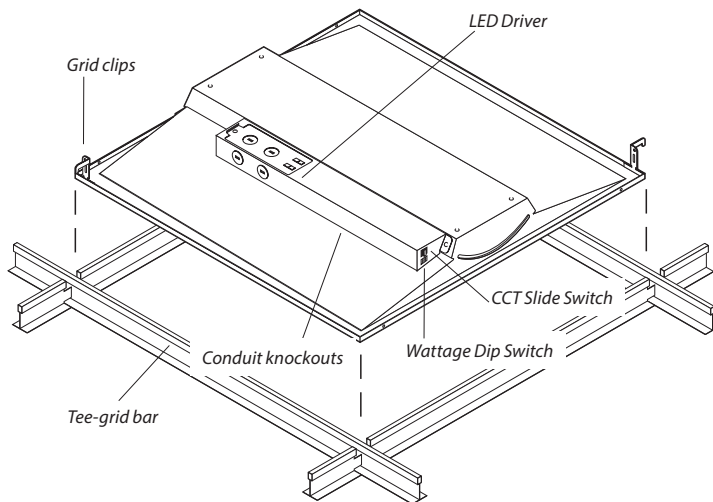

### ALTERNATIVE MOUNTING OPTIONS

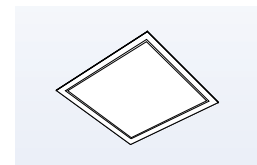

Recessed drywall mounted

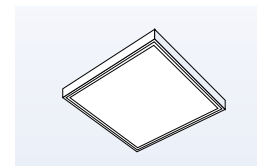

Surface mounted

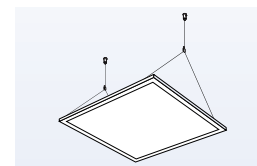

Suspension mounted

## ORDERING INFORMATION

Listed below are the included wattage settings and lumens for each model number.

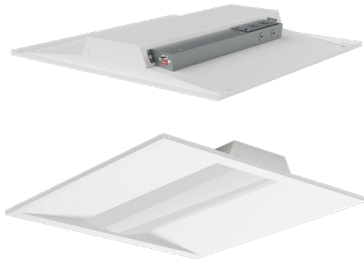

### 2' X 2'

ROOT MODEL #	DESCRIPTION		
<b>VLT2</b>	<b>2X2 LED Volumetric Troffer</b>		
EXT. MODEL #	WATTAGE	CCT	LUMENS
VLT23518	18	3500	2,250
VLT23520	20	3500	2,500
VLT23525	25	3500	3,125
VLT23530	30	3500	3,750
VLT23536	36	3500	4,500
VLT24018	18	4000	2,250
VLT24020	20	4000	2,500
VLT24025	25	4000	3,125
VLT24030	30	4000	3,750
VLT2	36	4000	4,500
VLT25018	18	5000	2,250
VLT25020	20	5000	2,500
VLT25025	25	5000	3,125
VLT25030	30	5000	3,750
VLT25036	36	5000	4,500

### 2' X 4'

ROOT MODEL #	DESCRIPTION		
<b>VLT4</b>	<b>2X4 LED Volumetric Troffer</b>		
EXT. MODEL #	WATTAGE	CCT	LUMENS
VLT43525	25	3500	3,125
VLT43530	30	3500	3,750
VLT43540	40	3500	5,000
VLT43545	45	3500	5,625
VLT43550	50	3500	6,250
VLT44025	25	4000	3,125
VLT44030	30	4000	3,750
VLT44040	40	4000	5,000
VLT44045	45	4000	5,625
VLT4	50	4000	6,250
VLT45025	25	5000	3,125
VLT45030	30	5000	3,750
VLT45040	40	5000	5,000
VLT45045	45	5000	5,625
VLT45050	50	5000	6,250

### 1' X 4'

ROOT MODEL #	DESCRIPTION		
<b>VLT1</b>	<b>1X4 LED Volumetric Troffer</b>		
EXT. MODEL #	WATTAGE	CCT	LUMENS
VLT13518	18	3500	2,250
VLT13520	20	3500	2,500
VLT13525	25	3500	3,125
VLT13530	30	3500	3,750
VLT13536	36	3500	4,500
VLT14018	18	4000	2,250
VLT14020	20	4000	2,500
VLT14025	25	4000	3,125
VLT14030	30	4000	3,750
VLT1	36	4000	4,500
VLT15018	18	5000	2,250
VLT15020	20	5000	2,500
VLT15025	25	5000	3,125
VLT15030	30	5000	3,750
VLT15036	36	5000	4,500

Each extended model # is individually listed with DLC. The highest wattage is listed under the root model # with 4000K CCT.

## EMERGENCY BATTERY BACKUP

MODEL #	DESCRIPTION	USAGE
EB10	10W Emergency Battery Backup	Supplies battery backup to an individual fixture for up to 90 minutes. <u>Must be ordered with EBCM or EBAM indicator module.</u>
EBCM	Ceiling-mounted Indicator Module	In grid ceiling applications, this unit connects to the EB10 and is recess mounted in an adjacent panel where it displays the unit's current status of operation.
EBAM	Adhesive-mounted Indicator Module	In drywall/open ceiling applications, this unit connects to the EB10 and is mounted via adhesive, where it displays the unit's current status of operation.

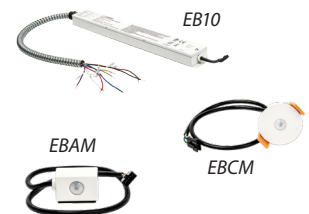

## ORDERING INFORMATION

### DRYWALL MOUNT KIT

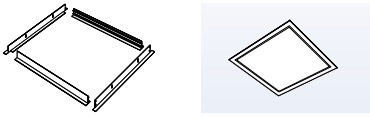

### SURFACE MOUNT KIT

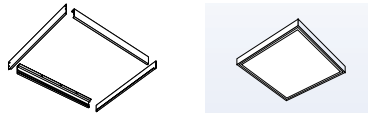

### SUSPENSION MOUNT KIT

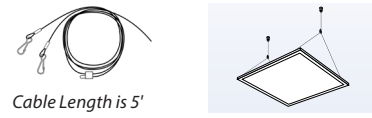

## DRYWALL MOUNT KIT

MODEL #	DESCRIPTION	USAGE	OUTSIDE DIMENSIONS
FPAM224	2x4 Drywall Mount Kit	Recess mount 2x4 Panels in ceiling surfaces	49.44" x 25.46" x 1.65"
FPAM222	2x2 Drywall Mount Kit	Recess mount 2x2 Panels in ceiling surfaces	25.46" x 25.46" x 1.65"
FPAM221	1x4 Drywall Mount Kit	Recess mount 1x4 Panels in ceiling surfaces	49.44" x 13.57" x 1.65"

## SURFACE MOUNT KIT

MODEL #	DESCRIPTION	USAGE	OUTSIDE DIMENSIONS
PTAM204	2x4 Surface Mount Kit	Surface mount 2x4 Panels to ceiling surfaces	47.85" x 23.94" x 3.1875"
PTAM202	2x2 Surface Mount Kit	Surface mount 2x2 Panels to ceiling surfaces	24.07" x 23.94" x 3.1875"
PTAM301	1x4 Surface Mount Kit	Surface mount 1x4 Panels to ceiling surfaces	47.85" x 11.97" x 3.1875"

## SUSPENSION MOUNT KIT

MODEL #	DESCRIPTION	USAGE	WEIGHT RATING	MAX DISTANCE FROM CEILING
PTAM214	2x4 Suspension Mount Kit	Suspend 2x4 Panels from ceiling	25 lbs	4.45'
PTAM212	2X2 Suspension Mount Kit	Suspend 2x2 Panels from ceiling	25 lbs	4.45'
PTAM211	1X4 Suspension Mount Kit	Suspend 1x4 Panels from ceiling	25 lbs	4.45'

## HAVE QUESTIONS?

Our Customer Service team can help. Call us at 800-860-3392 or send an email to [customerservice@litetronics.com](mailto:customerservice@litetronics.com)