

Area Light Direct Rotatable Mount (ALADRM)

Installation Instructions

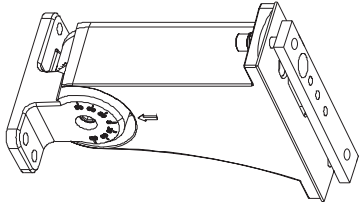

SAFETY INSTRUCTIONS AND WARNINGS

- When using electrical equipment, basic safety precautions should always be observed.
- This product must be installed in accordance with the applicable installation code by a person familiar with the construction and operation of the product and the hazards involved.
- Installation should only be conducted by a qualified electrician in accordance with NEC and any relevant local building codes.
- Be certain electrical power is OFF before and during installation and maintenance.
- To prevent wiring damage or abrasion, do not expose wiring to edges of sheet metal or sharp objects.

WHAT COMES IN THE BOX

Direct Rotatable Mount
Allen Head Bolts M8 * 25mm (x4)
Spring Washer M8 (x4)
Flat Washer M8 (x4)
Ground Washer M8 (x1)
Installation Instructions

REQUIRED TOOLS

Allen Wrench / Hex Key

INSTRUCTIONS

Before Installation, carefully remove all parts from the packaging. Inspect product for defects due to shipping.
Always turn off the power supply from main circuit breaker first!

DIRECT ROTATABLE MOUNT INSTALLATION

1. Separate base and mount head by removing M8 screw.
On mount head remove the four screws to open side lid. (Figure 1)

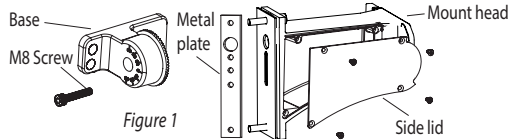

2. Run the input wire through the base (watch out not to scratch the wire).
Affix the base with screws and lock to the fixture. (Figure 2)

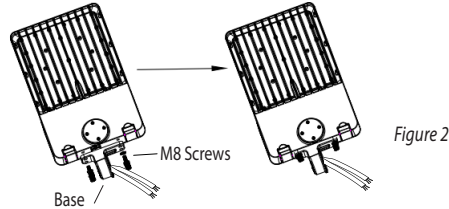

3. Pass the wires through the mount head (watch out not to scratch the wire). Install the mount head and keep M8 screw loose. (Figure 3)

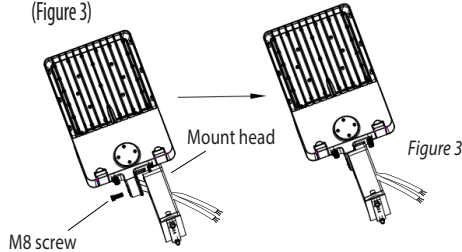

DIRECT ROTATABLE MOUNT SQUARE POLE INSTALLATION

1. Affix the direct rotatable mount to the square pole, pull the wire from pole into junction box, and connect the wires accordingly (refer to area light installation instructions for wiring diagram). (Figure 4)
2. Use four screws to close side lid back in place.
3. Installation complete. (Figure 5)
4. Turn power back on.

Note: Adjustable angle range is 0-35°.

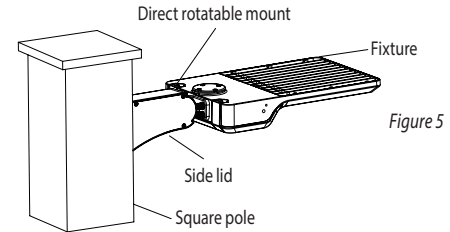
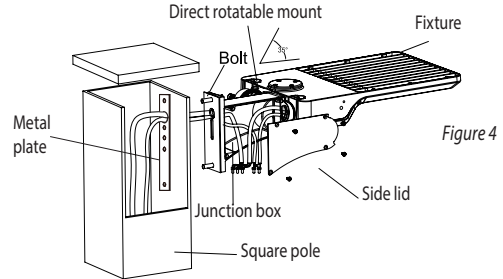

DIRECT ROTATABL MOUNT ROUND POLE INSTALLATION

1. For round pole installation, follow the previous steps. Remember to remove the square pole silicon gasket when installing the fixture on round poles. (Figure 6)

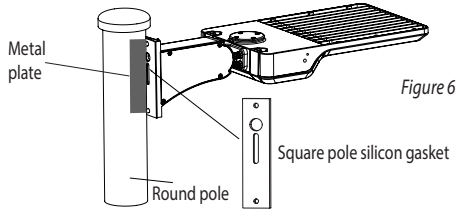

ALADRM - 150W ,200W 300W

Hole Pattern

Note: All measurements in MM.

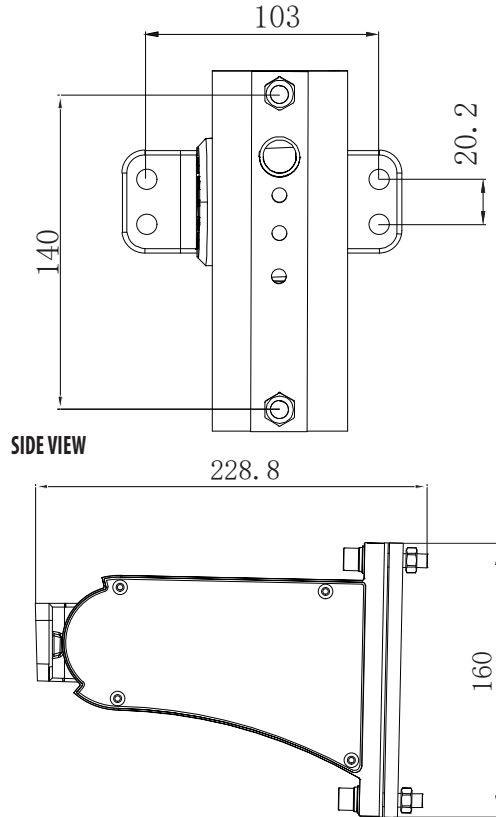

Thank you for choosing

LITETRONICS®

6969 W. 73rd Street
Bedford Park, IL 60638

WWW.LITETRONICS.COM

CustomerService@Litetronics.com or 1-800-860-3392



**RoHS
Compliant**

The information and product specifications contained in these instructions are based upon data believed to be accurate at the time of printing. This information is subject to change without notice and without incurring liability. If you have questions regarding specific product details, please contact us at 800-860-3392 or via email at customerservice@litetronics.com. To check for an updated version of these instructions, please visit www.litetronics.com.