

PROJECT:	
CATALOG #	
TYPE:	DATE:

## LED 2-IN-1 TRADITIONAL OR FULL CUT OFF WALL PACK

### DESCRIPTION

Litetronics LED 2-In-1 Traditional or Full Cut Off Wall Packs are available from 30W to 100W. The units are offered with selectable wattage and CCT (3000K, 4000K and 5000K), photocell, and pluggable sensor socket. Optional Sensors include PIR (SC005), Microwave (SC006) and our LiteSmart Sensor (SC008) enabling the same energy saving control but can be setup and managed on a group level via the LiteSmart mobile app to meet code and local ordinance compliance.

The fixtures offer ease of installation with swing-open unit to facilitate mounting and electrical connections and include EVA cotton pad for wall mount installation.



### FEATURES

- Photocell and pluggable sensor socket
- Compatibility with LiteSmart mobile app
- Field selectable wattages and CCT (3000K, 4000K, 5000K)
- 50,000-hour rated life
- 5-year warranty
- DLC 5.1 Premium

### MARKETS

- Building facades
- Garage and dock doors
- Loading dock and entry doors
- Safety & security lighting
- Schools, campuses
- Commercial, industrial
- Storage rental facilities
- Multi-family, apartment complex
- Columns & porte cochere

### MOUNTING

- EVA cotton pad for wall mounting

### CERTIFICATIONS



## SPECIFICATIONS

**Life (@L70):** 50,000 hours

**Warranty:** 5 years

### PERFORMANCE

**Operating temp:** -40F to 113°F (-40°C to 45°C)

**Efficacy (LPW):** 135

**CRI:** 80

### ELECTRICAL

**Input voltage:** 120-277V

**Input frequency:** 50/60Hz

**PF:** ≥.95

**THD:** ≤ 20%

**Surge protection:** 4KV

**Dimming:** 0-10V

**Minimum dimming:** N/A

**Aux. Voltage:** N/A

**Driver Class - WPC060:** N/A    **WPC100:** Class P

**Whip/Cord:** None

**Sensor:** Plug-In (Choice of MW, PIR, Bluetooth)

### MOUNTING

**Standard:** Standard Wall Mount.

### DIMENSIONS / WEIGHT

ORDER#	WIDTH	HEIGHT	DEPTH	WEIGHT
WPC060	14.37"	9.39"	4.90"	6.28 lbs.
WPC100	14.37"	9.39"	4.90"	6.72 lbs.

### OPTICAL

**Beam:** 93°

**Lens:** Polycarbonate Frosted

**UGR:** N/A

### PHYSICAL

**Finish:** Matte Powder Coat

**Color:** Dark Bronze

**Housing:** Painted Steel

### EMERGENCY BATTERY OPTION: WPC060E

**Wattage:** 8

**Voltage:** 120-277V

**Battery Life:** 90 Minutes

**System Life:** 50,000 hrs.

**Testing:** Push Button - For monthly and yearly self-testing.

**Indicator Light:** Located On Housing

**UL/ETL:** Pending

**Operating Temp:** 40F to 113°F (-40°C to 45°C)

**Recharge Time:** 24 Hours

### INDUSTRY STANDARDS/RATINGS

**Bug Rating**

**WPC060:** B2-U3-G2

**WPC100:** B3-U3-G3

**IP:** 65

**IK:** N/A

**Location:** Wet

**Outdoor Rated:** Yes

**IC:** No

**UL/ETL:** UL

**FCC:** Yes

**RoHS:** Yes

**DLC:** 5.1 Premium

### WPC060/WPC100

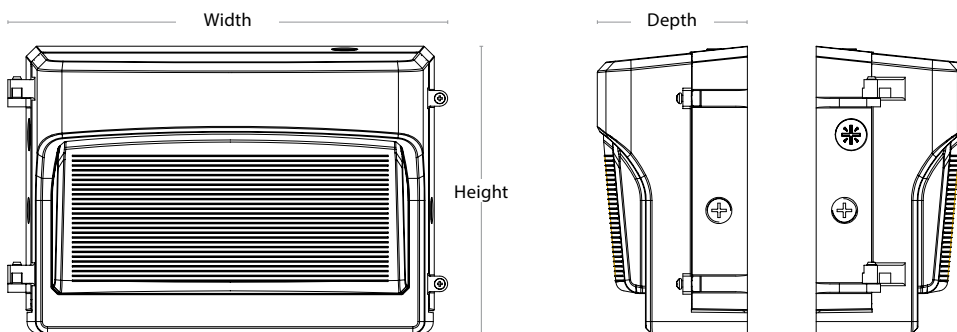

## PRODUCT OVERVIEW AND INSTALLATION

### WALL MOUNT INSTALLATION INSTRUCTIONS

1. Turn off power.

2. Use a screwdriver to remove the screws on both sides. (Figure 1)

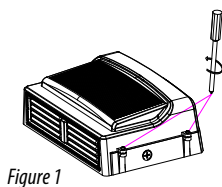

3. Open the fixture, pull out the connection terminals, and remove the upper cover of the fixture. (Figure 2)

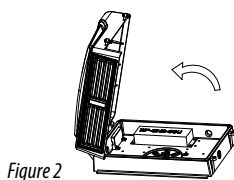

4. If optional sensor is to be installed, use a screwdriver to remove the sensor port plug. Otherwise, leave sensor port plug in place. (Figure 3)

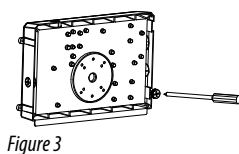

5. Drill through the mounting hole with an electric drill matching the mounting pattern of the electrical junction box. If optional sensor is to be installed, refer to 1-pin sensor socket installation guide for instructions. (Figure 5)

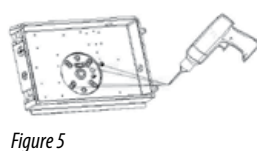

6. Attach the EV A cotton pad to back shell. (Figure 6)

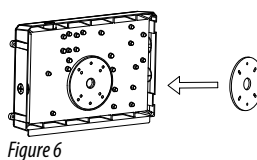

7. Pass the wire through the back hole. (Figure 7)

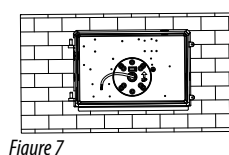

8. Install back mounting plate onto the mounting seat with screws. (Figure 8) See installation instructions for special function adjustments.

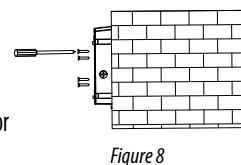

9. Connect L, N and G wires to the power supply as per Figure 1 and Figure 2. (Figure 9)

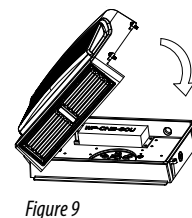

10. Install the cover of the fixture. (Figure 10)

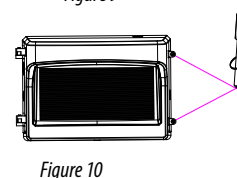

11. Make sure the installation is complete and secure before turning on the power

## ORDERING INFORMATION

Listed below are the selectable wattage settings and lumens for each model number.

WPC060/WPC060E/WPC100



ORDERING CODE	DESCRIPTION	WATTS	VOLTS	CCT (K)	LUMENS
WPC060	LED 2-In-1 Traditional or Full Cut Off Wall Pack	30   40   60	120-277V	3000   4000   5000	4,050   5,400   8,100
WPC060E	LED 2-In-1 Traditional or Full Cut Off Wall Pack with emergency battery backup	30   40   60	120-277V	3000   4000   5000	4,050   5,400   8,100
WPC100	LED 2-In-1 Traditional or Full Cut Off Wall Pack	60   80   100	120-277V	3000   4000   5000	8,100   10,800   13,500

## ACCESSORIES

SC010



SC005



SC006



SCR053



SC008



SCR054



## SENSORS & CONTROLS

ORDERING CODE	DESCRIPTION	USAGE
SC010	Elbow with 1 Pin Sensor Socket	Ordered separately - Required for all Plug-In sensors SC005, SC006, SC008.
SC005	Plug-in PIR Sensor	Enable occupancy sensing on pluggable fixtures.
SC006	Plug-in Microwave Sensor	Enable occupancy sensing on pluggable fixtures.
SCR053	Remote Control	Used (with SC005 and SC006 sensor) to adjust settings after installation.
SC008	Plug-in Bluetooth PIR Sensor with IR	This sensor enables wireless control of fixtures, or groups of fixtures, through the LiteSmart mobile app.
SCR054	Remote Control	Used to Commission LiteTronics "Next Generation" LiteSmart IR-Enabled Sensor.

## WIRELESS CONTROL WITH PLUGGABLE SENSORS



The optional MW (SC006), and PIR Sensor (SC005) use a remote control for easy setup and control of individual fixtures.



The smart PIR sensor uses a remote control (SCR054) to Commission and group Litetronics "Next Generation" LiteSmart IR-Enabled SC008 Sensor.



## LITESMART



LiteSmart is a mobile app that enables total management of lighting systems at the touch of your fingers. Within the app, all functionality can be set up and controlled; on/off, dimming, grouping, scene creation and time scheduling. Adjustments can also be made to the occupancy sensor settings, then implemented across an entire group in seconds.

- Total control over your lighting system
- Quick and easy changes that can be implemented in seconds across a group of fixtures
- Further energy reduction via occupancy sensing, and max wattage control
- Ability to create custom scenes based on specific needs, such as presentations
- Time scheduling that sets hours of operation per day



Set up and manage your space with LiteSmart.  
**Note:** Elbow with 1 Pin Sensor Socket and sensors sold separately.