

LITETRONICS®

2-In-1 Traditional or Full Cutoff Wall Pack Installation Instructions

WPC-Series

WPC060,

WPC060E,

WPC100

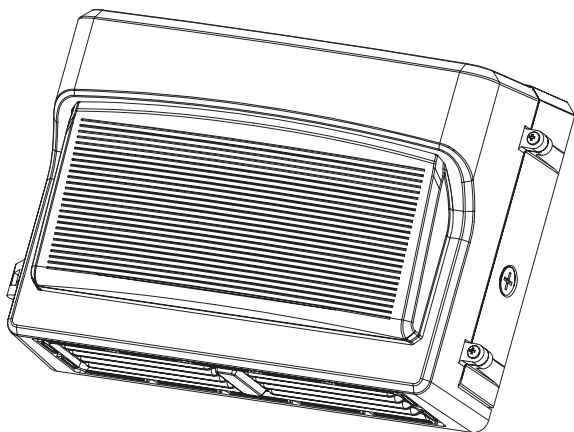

WHAT COMES IN THE BOX

Pluggable sensor socket
Photocell
EVA Cotton Pad

TOOLS NEEDED

Phillips Screwdriver or Allen Wrench
Power Drill

SAFETY INSTRUCTIONS AND WARNINGS

WHEN USING ELECTRICAL EQUIPMENT, BASIC SAFETY PRECAUTIONS SHOULD ALWAYS BE OBSERVED. READ CAREFULLY BEFORE INSTALLING FIXTURE. RETAIN THESE INSTRUCTIONS FOR FUTURE REFERENCE.

Litetronics fixtures must be wired in accordance with the National Electrical Code and all applicable local codes.

Risk of fire or electric shock. 2-In-1 traditional or full cutoff wall pack installation requires knowledge of luminaires electrical systems. If not qualified, do not attempt installation. Contact a qualified electrician.

Be certain electrical power is OFF before and during installation and maintenance.

2-In-1 traditional or full cutoff wall pack must be connected to a wiring system with an equipment – grounding conductor.

Make sure the supply voltage is the same as the rated luminaire voltage.

Only the open holes indicated in the photographs and/or drawings may be made or altered as a result of this kit installation. Do not leave any other open holes in an enclosure of wiring or electrical components.

To prevent wiring damage or abrasion, do not expose wiring to edges of sheet metal or sharp objects.

Suitable for wet locations.

ATTENTION

1. Please check if there is any damage during shipping. If so, please contact Litetronics customer service.
2. Please read the installation instruction carefully to check whether all the accessories are included.
3. After confirmation, install the fixture according to installation steps.
4. This fixture is available in outdoor usage, the distance from fixture to ground should be more than 2m.

INSTALLATION PROCEDURE

WIRING DIAGRAM

120V & 277V



Figure 1

240V

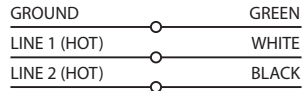

Figure 2

Warning: During grounding, make sure the ground wire of the driver and fixture housing are connected together with the ground/bonding wire of the local power supply.

WALL MOUNT INSTALLATION INSTRUCTIONS

1. Turn off power.

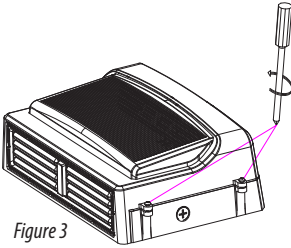

Figure 3

2. Use a screwdriver to remove the screws on both sides. (Figure 3)

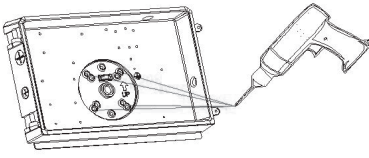

Figure 5

4. Drill through the mounting hole with an electric drill matching the mounting pattern of the electrical junction box. (Figure 5)

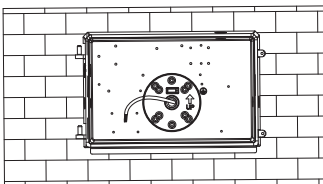

Figure 7

6. Pass the wire through the back hole. (Figure 7)

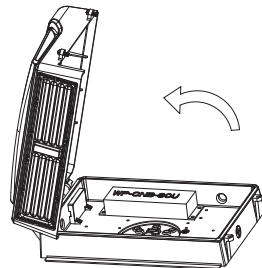

Figure 4

3. Open the fixture, pull out the connection terminals, and remove the light engine of the fixture. (Figure 4)

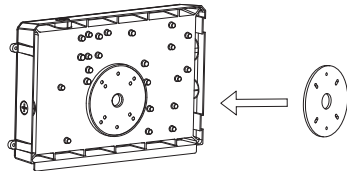

Figure 6

5. Attach the EV A cotton pad to back shell. (Figure 6)

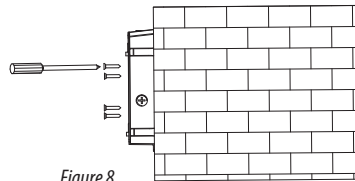
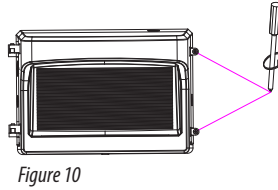
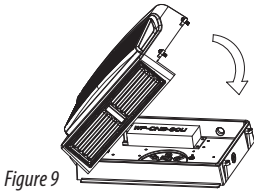

Figure 8

7. Install back mounting plate onto the mounting seat with screws. (Figure 8)

Follow special functions instructions for light engine selection, CCT and wattage adjustments below. (Figure 11 and Figure 12)

INSTALLATION PROCEDURE



8. Before closing, connect L, N and G wires to the power supply as per **Figure 1** and **Figure 2**. (Figure 9)

9. Install the cover of the fixture. (Figure 10)

10. Make sure the installation is complete and secure before turning on the power.

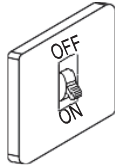

SPECIAL FUNCTIONS INSTRUCTIONS

2 IN 1 CONTROLLER (LIGHT ENGINE SELECTION SWITCH & CCT ADJUSTMENT)

1. Set LED Selector switch as desired:

F = Bottom LED Engine

S = Both LED Light Engines

2. Select CCT Color as desired using CCT Switch (Figure 11)

Note: Please turn off the power before adjusting the color temperature.

WATTAGE ADJUSTMENT INSTRUCTION

Turn the wattage adjustment knob to desired wattage selection (Figure 12). Lumen output will change to the corresponding wattage.

Note: Please turn off the power before adjusting the wattage.

After setting special functions, return to **step 8**.

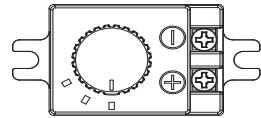
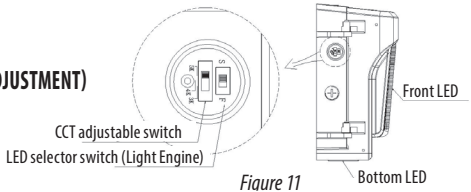

WPC060, WPC060E

WATTAGE KNOB SETTINGS

60W	40W	30W
-----	-----	-----

Note: Watts default setting set to **60W**.

CCT SLIDE SWITCH SETTINGS

5000K	4000K	3000K
-------	-------	-------

Note: CCT default setting set to **5000K**.

WPC100

WATTAGE KNOB SETTINGS

100W	80W	60W
------	-----	-----

Note: Watts default setting set to **100W**.

CCT SLIDE SWITCH SETTINGS

5000K	4000K	3000K
-------	-------	-------

Note: CCT default setting set to **5000K**.

#WPC060E WITHOUT SWITCH

1. Begin by following steps from 1 through 8.

2. Connect the battery's connector.

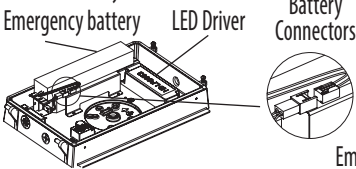

Connection complete

Note: Follow Emergency Test Button procedure after connection.

3. After connections are made, follow steps 9 and 10. (Continue to next page for more information.)

INSTALLATION PROCEDURE

EMERGENCY BATTERY BACKUP OPERATION

When the AC power goes out, the emergency driver detects the AC power outage and automatically switches to the working emergency mode. **1.** When power outage occurs, emergency battery backup will last for 90 minutes. The red indicator light will off. **2.** When power is restored, the emergency battery will begin to recharge. Recharge time is 24 hours. **3.** When the indicator light is red, the battery is charging.

MAINTENANCE

Although no routine maintenance is required to keep the emergency battery backup functional, it should be checked periodically to ensure that it is working. The following schedule is recommended:

- Test the emergency operation of the fixture at 30-day intervals for a minimum of 30 seconds.
- Conduct a 90-minute discharge test once a year. Fixture should operate for at least 90 minutes.

EMERGENCY TEST BUTTON PROCEDURE

Press and hold the emergency power test button (Figure 13) to test the wall pack in emergency detection mode LED light will be lit in emergency mode.

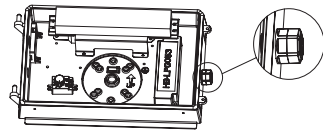
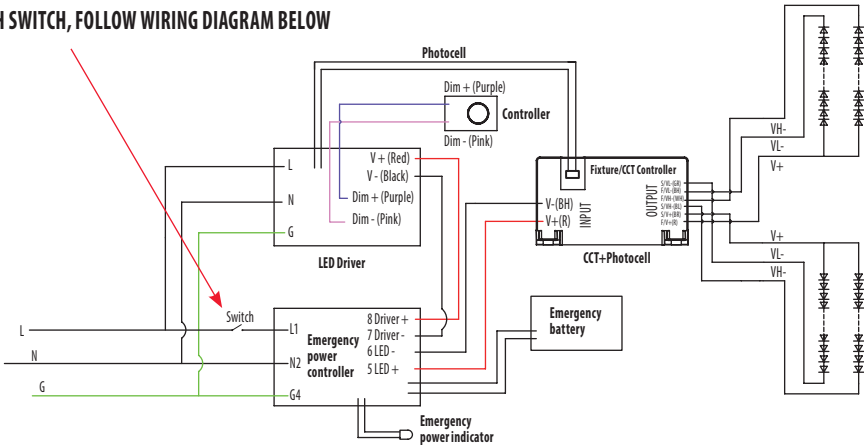

Figure 13

WITH SWITCH, FOLLOW WIRING DIAGRAM BELOW



Thank you for choosing

LITETRONICS®

6969 W. 73rd Street
Bedford Park, IL 60638

WWW.LITETRONICS.COM

CustomerService@Litetronics.com or 1-800-860-3392



RoHS
Compliant

The information and product specifications contained in these instructions are based upon data believed to be accurate at the time of printing. This information is subject to change without notice and without incurring liability. If you have questions regarding specific product details, please contact us at 800-860-3392 or via email at customerservice@litetronics.com.

To check for an updated version of these instructions, please visit www.litetronics.com.

11/10/23 - V1.7