

LITETRONICS®

1'x4' LED Retrofit

Installation Instructions

Ordering Code:

RF16UQT1XXC

RF32UQT1XXC

RF32UHT1XX

RF45UQT1XXC

RF45UHT1XX

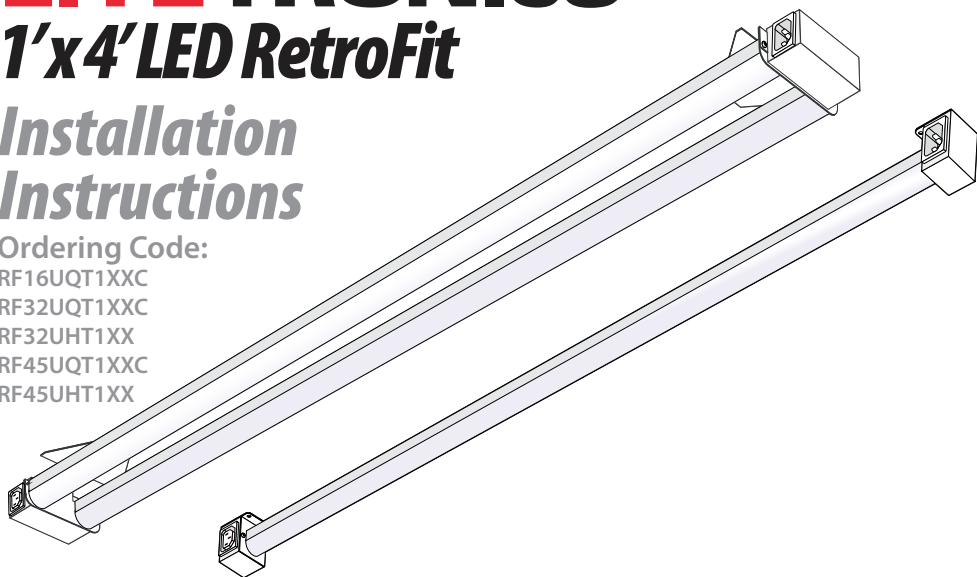

**PLEASE READ THESE INSTRUCTIONS
BEFORE INSTALLATION OF THE FOLLOWING:**

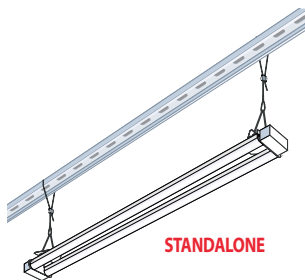
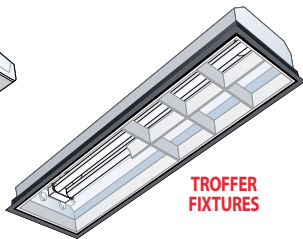
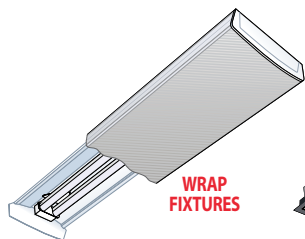
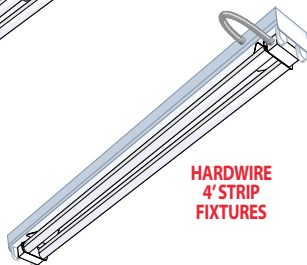
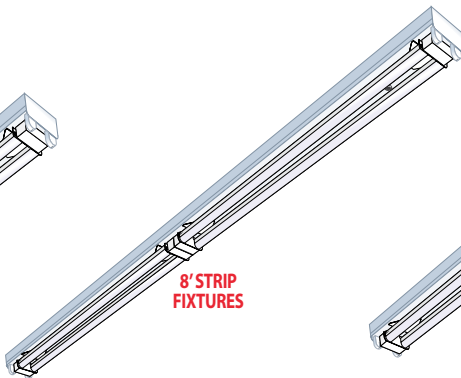
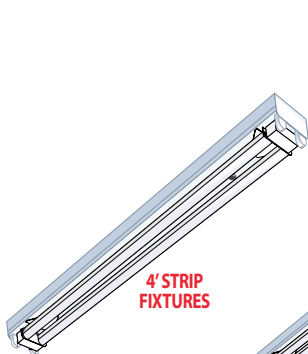

INTRODUCTION & TABLE OF CONTENTS

Congratulations on the purchase of your 1x4 Retrofit. It is usable for a range of installations. Some of the most popular ones are included here.

Section 1- 4' OR 8' STRIP FIXTURE INSTALL	5
Section 2- HARDWIRE STRIP FIXTURE INSTALL	10
Section 3- TROFFER OR WRAP INSTALL	15
Section 4- STANDALONE USE	19

SAFETY INSTRUCTIONS AND WARNINGS

CRITICAL SAFETY INSTRUCTIONS: Installation should only be conducted by a qualified electrician in accordance with NEC and any relevant local building codes.

LED RETROFIT WARNINGS: Risk of fire or electric shock. LED RetroFit kit installation requires knowledge of luminaire electrical system. If not qualified, do not attempt installation. Contact a qualified electrician. Luminaire wiring and electrical parts may be damaged when drilling for installation of LED RetroFit kit. Check for enclosed wiring and components. Do not make or alter any open holes in the enclosure of wiring or electrical components during kit installation. If installing 4' or 8' strip fixture insure width is greater or equal to 2".

WARNING: Risk of fire or electric shock. Install this kit only in luminaires that have the construction features and dimensions shown in the photographs and/or drawings and where the input rating of the retrofit kit does not exceed the input rating of the luminaire. Only those open holes indicated in the photographs and/or drawings may be made or altered as a result of kit installation. Do not leave any other open holes in an enclosure of wiring or electrical components.

To prevent wiring damage or abrasion, do not expose wiring to edges of sheet metal or other sharp objects.

This LED RetroFit Kit and Junction Box Cover shall only be installed into a UL/CUL listed luminaire with a steel enclosure. DO NOT INSTALL THIS RETROFIT KIT INTO LUMINAIRES WITH NON-FERROUS METAL OR POLYMERIC ENCLOSURES

Do not use with dimmers.

DISCONNECT SAFETY INSTRUCTIONS:

WARNING - This is a current rated device. Use in applications involving amperage beyond its rating can be dangerous and cause electrical fires. See note on this page for allowable current and voltage levels and do not exceed those levels.

DANGER - NEVER remove wires from product as contact with electricity can cause serious injury or death. Shut off power at the circuit breaker or remove fuse when installing this product.

SAFETY NOTICE - Improperly installed electrical wiring can be dangerous and cause electrical fires. This product must be used in accordance with the current rating and wire sizes listed.

COPPER to COPPER ONLY. Do not use on Aluminum. Temperature rating: 105° C (221° F) maximum. Flame Rated UL94V-0. This product is intended for use in a UL/C-UL listed Fluorescent Recessed or surface-mounted luminaire, Type IC or Non-IC, with the dimensions specified.

INCLUDED CN-02 CONNECTOR FOR RETROFIT POWER



Line Side (4 ports)

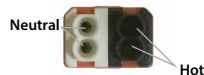

TOOLS AND MATERIALS FOR INSTALLATIONS



Step Ladder



Wire Stripper

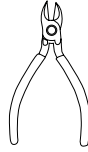

Wire Cutter



Pliers



Drill



1/4" Nut driver

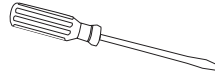

Screw Driver

What comes in the box:

1x4 LED RetroFit- 1 Tube



or

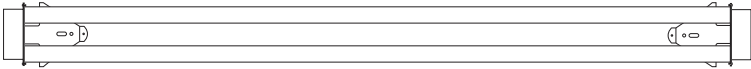

1x4 LED RetroFit- 2 Tube

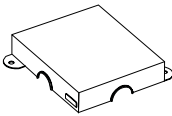

Magnetic Junction
Box Cover

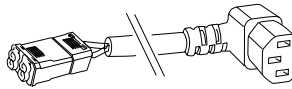

Power Cord (input wire with
Luminaire disconnect both female
and male parts are included)

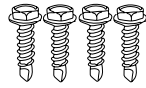

(4) Self-tapping
screws, #8 x 1/2"



Conduit with 14AWG Wire
(with RF32UHT1XX
and RF45UHT1XX Only)



Split Snap Bushing

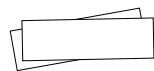

(2) Labels

1X4 ACCESSORIES

Not included but available for purchase

Power Cords



4' Lamp to lamp extension cable
(RFAC-4FT)



8" Lamp to lamp extension cable
(RFAC-8IN)



Direct dual connector
(RFAC)

Tools & Kits



Wire cable accessories
for stand alone installations
(RFAXPVL5)



20mm bi-metal hole saw
(RFAHS-20)

Before

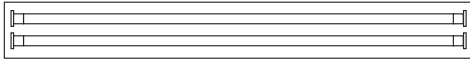

1x4 Strip Fixture with T8 Tubes

After

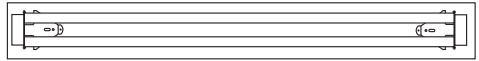

1x4 Strip Fixture with LED Retrofit

READ ALL INSTRUCTIONS BEFORE BEGINNING INSTALLATION

Installation Notes:

1. Retrofit must be installed to a grounded luminaire.
2. 1x4 strip install does not require the use of a junction box.
3. Ballast cover should be mechanically secured to physically support the Retrofit.

1. Turn off the power to the fixture from the circuit breaker.

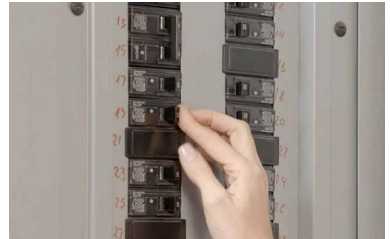

2. Remove the existing fluorescent tubes. Recycle according to EPA guidelines (EPA.Gov).



3. Open the fixture cover (belly pan) to expose the ballast and set it aside.

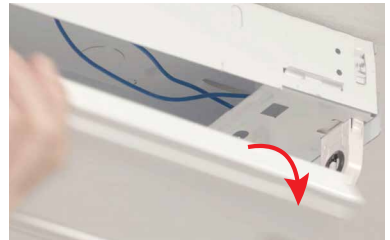

4. Disconnect the existing input and output ballast leads close to the ballast enclosure and remove the leads (black and white wires). Lampholders may remain in place but the leads to the lampholders should be cut at the lampholder and at the ballast.

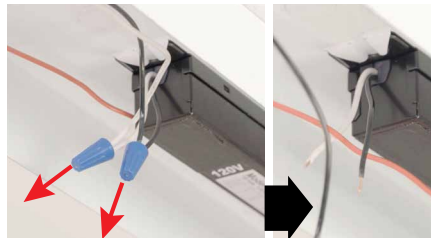

RF16UQT1XXC, RF32UQT1XXC, RF45UQT1XXC 4' & 8' STRIP FIXTURE INSTALL

5. Connect incoming branch power leads to the included female disconnect by pushing the wires into the corresponding color coded black and white holes in back of connector.

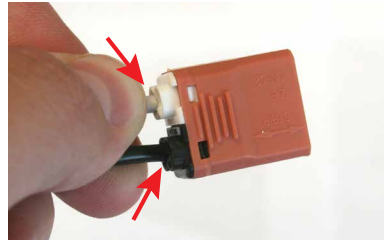

6. Punch hole through side knockout of strip fixture or drill a hole through the center of the cover (set aside in step 3) near the incoming branch power wires with 20mm bi-metal hole saw (sold separately ordering code RFAHS-20).



7. Clip the snap bushing onto the included power cord.

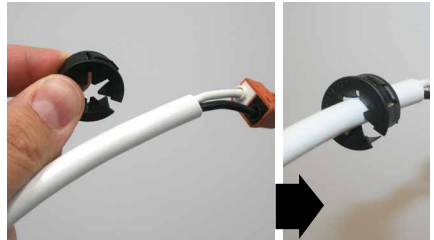

8. Insert the connector and power cord into knock out or drilled hole. Fix bushing to panel hole. Reconnect the male and female halves of the Luminaire disconnect.

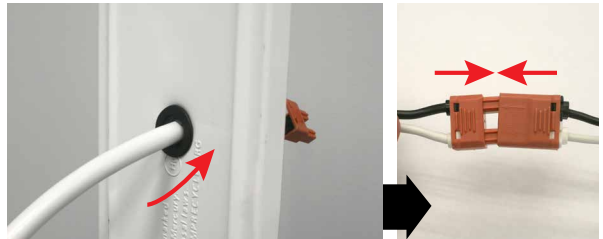

9. Reaffix the fixture cover (belly pan).



RF16UQT1XXC, RF32UQT1XXC, RF45UQT1XXC 4' & 8' STRIP FIXTURE INSTALL

10. Attach the RetroFit to the fixture cover using the rare earth magnets. Thread power cord between the two tubes of the LED RetroFit. Position the LED RetroFit to preferred alignment. Secure to the fixture with 2 of the included self-tapping screws.



▶ Route and position Retrofit wiring within luminaire enclosure away from mounting hole where screws will be inserted.

11. Plug the power cord connector into the RetroFit power socket.



12. Apply both included labels to the fixture.



13. Restore the power and you're done!



HOW TO USE TWO 1'X4' RETROFITS TO CREATE 8' STRIP

▶ For 8' install. Do not restore power until you complete steps 1a-1e below.

1a. Place and align the second 1' x 4' LED Retrofit with the C14 socket as close to the first LED Retrofit as needed to allow the use of RFAC dual connector (or cable). The magnets will hold it in position.



1b. Push the RFAC dual connector into the sockets to connect both LED Retrofits together.



1c. Align the second fixture and secure with the 2 included self-tapping screws.



▶ Unused branch circuits supplying interconnected retrofit luminaires should be properly terminated.

1d. Apply both included labels to the fixture.



HOW TO USE TWO 1'X4' RETROFITS TO CREATE 8' STRIP

1e. Restore the power and you're done! You have combined two 1'x4' Retrofits into an 8' fixture.



Our 1x4's can be assembled into long chains off one power source depending on Retrofit wattage. Connect retrofits when aligned together using the dual connector (RFAC). Connect retrofits together when up to 8" apart using 8in lamp to lamp extension cable (RFAC-8IN). Connect retrofits together when 8" - 4' apart using 4ft lamp to lamp extension cable (RFAC-4FT). Cables shown on page 4.

Maximum number of units by Watts

16W = 36 Retrofits

32W = 18 Retrofits

45W = 12 Retrofits

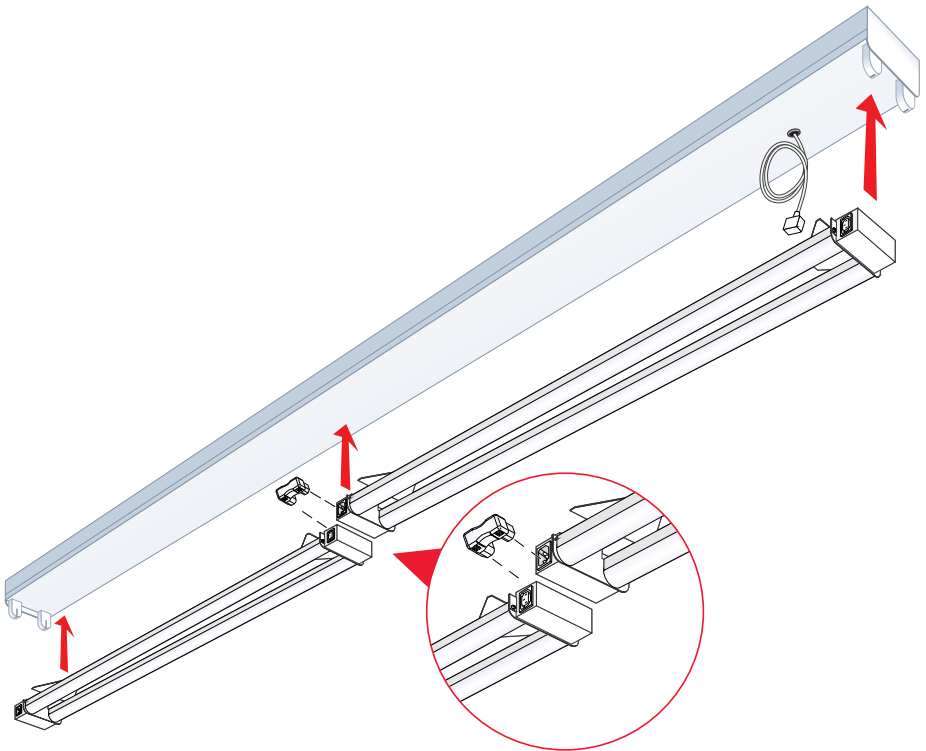

Section 2 RF32UHT1XX, RF45UHT1XX, RF32UQT1XXC AND RF45UQT1XXC HARDWIRE STRIP FIXTURE INSTALL

Before



1x4 Hardwire Strip Fixture with T8 Tubes

After



1x4 Hardwire Strip Fixture with LED Retrofit

READ ALL INSTRUCTIONS BEFORE BEGINNING INSTALLATION

Installation Notes:

1. Retrofit must be installed to a grounded luminaire.
2. Hardwire install does not use a junction box.
3. Ballast cover should be mechanically secured to physically support the Retrofit.

1. Turn off power to the fixture from the circuit breaker.
2. Remove existing fluorescent tubes. Recycle according to EPA guidelines (EPA.Gov).
3. Remove fixture cover (belly pan) to expose the ballast and set it aside.
4. Disconnect ballast wires from the incoming electrical lines. (Black and white wires).

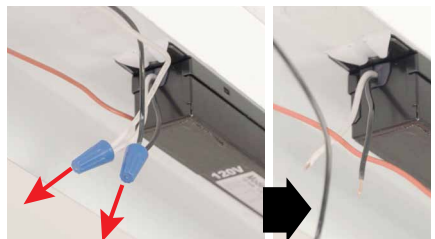
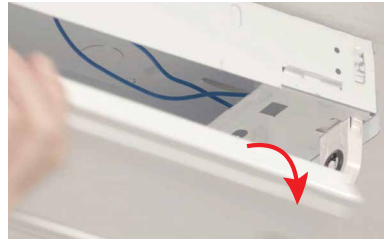

RF32UHT1XX, RF45UHT1XX, RF32UQT1XXC AND RF45UQT1XXC HARDWIRE STRIP FIXTURE INSTALL

5. On the LED RetroFit RF32UHT1XX and RF45UHT1XX open the end cover with the Litetronics logo by removing both screws.



6. Once open, the internal black, white and green/yellow wires to the LED tubes are visible.

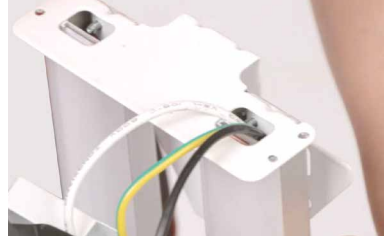

7. Strip the black, white and green/yellow wires coming from the tubes of the LED Retrofit to expose about 1/4" of wire.



8. Remove chosen knockout from the RetroFit end cover and make the fixture hole to connect the conduit.

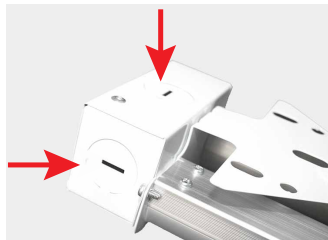

End Cover



Fixture Hole

9. Remove the nut from the conduit.

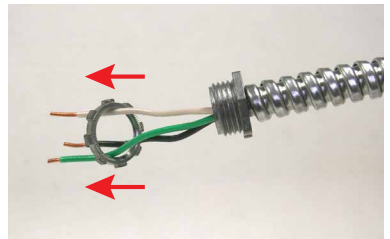

RF32UHT1XX, RF45UHT1XX, RF32UQT1XXC AND RF45UQT1XXC HARDWIRE STRIP FIXTURE INSTALL

10. Insert the conduit wires (black, white & green) through the hole of end cover. Place the conduit nuts over the three conduit wires inside cover. After that, push conduit end into knockout hole and secure with conduit nut.

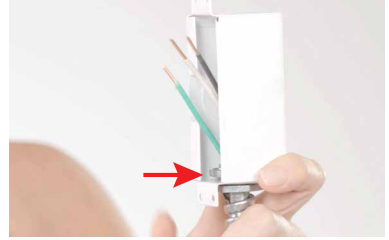

11. Connect conduit wires to LED RetroFit using wire nuts.
-Black to black
-White to white
-Green to green/yellow.



12. Replace end cover, and secure it with the two screws.



13. The wires on other end of the conduit go into the fixture hole. Remove the conduit nut. Push the three wires into the fixture hole, then through the conduit nut, and secure. Connect conduit wires to incoming electrical lines inside fixture. Connect black to black, white to white with wire nuts. Then connect the green/yellow wire to ground screw of strip.

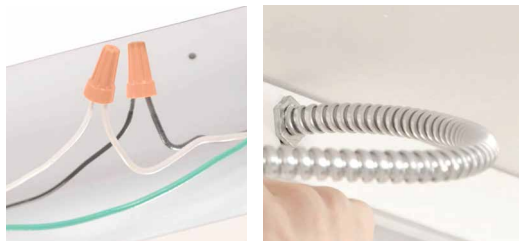

RF32UHT1XX, RF45UHT1XX, RF32UQT1XXC AND RF45UQT1XXC HARDWARE STRIP FIXTURE INSTALL

14. Reaffix fixture cover (belly pan).



15. Attach fixture belly pan to your RetroFit with the rare earth magnets. Slide RetroFit to preferred alignment. Secure it to the fixture with the 2 included self-tapping screws.



16. Apply both included labels to fixture.



WARNING: IF RETROFITTING 8' STRIP, DO NOT RESTORE POWER YET. CONTINUE WITH 8' INSTALL STEPS 1A-1E BELOW.

17. Restore the power and you're done!



RF32UHT1XX, RF45UHT1XX, RF32UQT1XXC AND RF45UQT1XXC HARDWARE STRIP FIXTURE INSTALL

▶ For 8' install. Do not restore power until you complete steps 1a-1e below.

1a. Place and align the second 1' x 4' Retrofit with the C14 socket as close to the first Retrofit as needed to allow use of Retrofit accessory connector.



1b. Place the dual connector (RFAC) into the sockets to connect both the LED Retrofits together.



1c. Align the second fixture and secure with 2 included self-tapping screws



▶ Any unused branch power circuits supplying interconnected retrofit luminaires should be properly terminated.

1d. Apply both included labels to the fixture.



1e. Restore the power and you're done!



Our 1x4's can be assembled into long chains off one power source depending on Retrofit wattage. Connect retrofits when aligned together using the dual connector (RFAC). Connect retrofits together when up to 8" apart using 8in lamp to lamp extension cable (RFAC-8IN). Connect retrofits together when 8"- 4' apart using 4ft lamp to lamp extension cable (RFAC-4FT). Cables shown on page 4.

Maximum number of units by Watts

16W = 36 Retrofits

32W = 18 Retrofits

45W = 12 Retrofits

Section 3

RF32UQT1XXC AND RF45UQT1XXC TROFFER OR WRAP INSTALL

Before

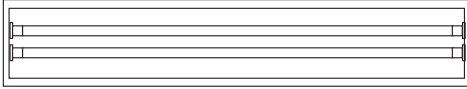

1x4 Troffer Fixture with T8 Tubes

After

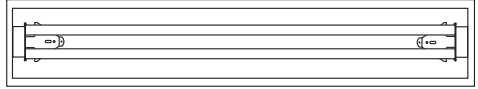

1x4 Troffer Fixture with LED Retrofit

READ ALL INSTRUCTIONS BEFORE BEGINNING INSTALLATION

Installation Notes:

1. Troffer or wrap install requires the use of a junction box.
 1. Turn off power to fixture from circuit breaker.
 2. Open and remove fixture cover.
- NOTE:** RF45UQT1XXC is designed for retrofitting a recessed luminaire with an open lamp compartment and not for retrofitting a recessed luminaire with a diffuser that fully encloses the lamp compartment.
3. Remove fluorescent tubes and ballast cover. Recycle tubes according to EPA guidelines (EPA.Gov).



RF32UQT1XXC (closed fixture)



RF45UQT1XXC (open fixture)



RF32UQT1XXC AND RF45UQT1XXC TROFFER OR WRAP INSTALL

4. Disconnect ballast wires from the incoming electrical line. (black and white wires)

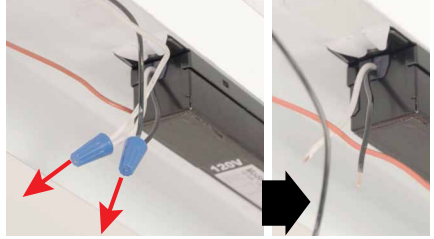

5. Remove lamp holders and mounting bracket.



6. Unscrew and remove ballast from fixture.



▶ If you are installing LED retrofit into a wrap fixture, instead of removing the lamp holders, just cut the remaining ballast wires as close to the lamp holders as possible.

7. Push the incoming electrical wire leads into the back of the included female disconnect. They will lock in place.



8. Connect the male disconnect to the female disconnect attached to the included power cord.

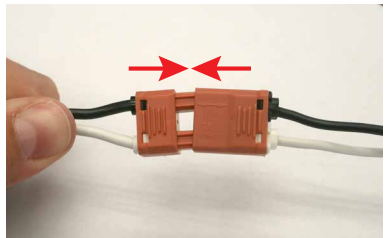

RF32UQT1XXC AND RF45UQT1XXC TROFFER OR WRAP INSTALL

9. Fully cover the attached disconnect and incoming electrical wires with provided magnetic junction box cover. Make sure the power cord is aligned to allow connection to the LED RetroFit.



10. Secure junction box with 2 of the included self-tapping screws.



11. Thread power cord between the two tubes of the LED RetroFit. Affix the LED RetroFit to the fixture using the rare earth magnets. Slide the LED RetroFit to preferred alignment and secure to the fixture with 2 of the included self-tapping screws.



12. Plug power cord into Retrofit power socket.



RF32UQT1XXC AND RF45UQT1XXC TROFFER OR WRAP INSTALL

13. Apply both included labels to fixture.



14. Replace the lens/fixture cover.



RF32UQT1XXC (closed fixture)



RF45UQT1XXC (open fixture)

15. Restore the power and you're done!



Section 4 RF32UHT1XX, RF45UHT1XX, RF32UQT1XXC AND RF45UQT1XXC STANDALONE USE

READ ALL INSTRUCTIONS BEFORE BEGINNING INSTALLATION

Installation Notes:

The LED RetroFit can be installed as a luminaire when hardwired and hung using the wire cable accessory (Ordering Code RFAXPVL5 sold separately).

1. Turn off the power to the fixture from the circuit breaker.



2. Open the end cover with Litetronics logo by removing both screws of the LED RetroFit.



3. Cut the black, white and green/yellow wires close to the power socket of the LED RetroFit.



4. Strip the black, white and green/yellow wires to expose about 1/4" of wire.



RF32UHT1XX, RF45UHT1XX, RF32UQT1XXC AND RF45UQT1XXC STANDALONE USE

5. Remove the chosen knockout from end cover to make hole to connect conduit.

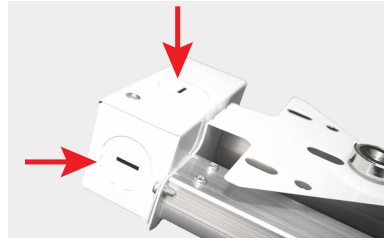

6. Unscrew the conduit nut from the conduit.

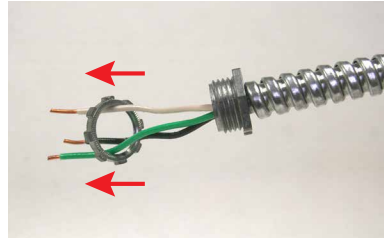

7. Insert the three conduit wires (black, white & green) through the hole in end cover.

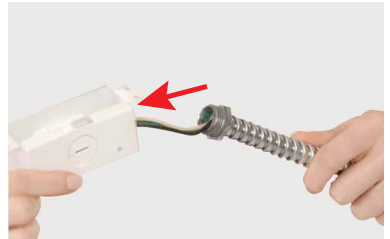

8. Then place the conduit nut over the three conduit wires inside end cover. After that, place conduit through knockout hole and secure with conduit nut.

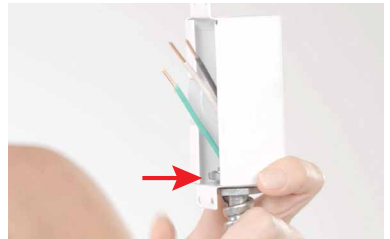

RF32UHT1XX, RF45UHT1XX, RF32UQT1XXC AND RF45UQT1XXC STANDALONE USE

9. Connect conduit wires to the RetroFit with wire nuts. Connect black to black, white to white and green to green/yellow.



CAUTION: To avoid risk of an electric shock, do not connect wires from conduit directly to the socket.

10. Replace the end cover you removed earlier and secure it with 2 screws.



Now, it is time to mechanically hang the light using the wire cable accessories.



Wire cable accessories
for stand alone installations
(RFAXPVL5)

11. Thread the non loop side of the cable into the cable lock, and pull the cable through the lock.



12. Loop cable around ceiling or service attachment point and pass tail end of cable through the other hole of the cable lock.



RF32UHT1XX, RF45UHT1XX, RF32UQT1XXC AND RF45UQT1XXC STANDALONE USE

13. Pull the tail end of the cable through the cable lock so the LED RetroFit hangs at desired height.



14. Repeat steps 12-14 with the second wire cable and lock.

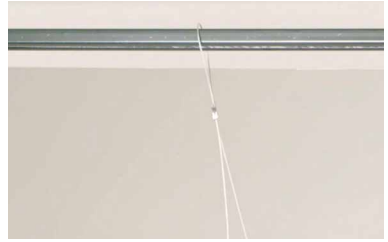

15. Put both V hooks in the loops of the cables.



16. Locate the holes on the back of the mounting bracket of both ends of the LED RetroFit.



RF32UHT1XX, RF45UHT1XX, RF32UQT1XXC AND RF45UQT1XXC STANDALONE USE

17. Insert both V hooks into the holes on the mounting bracket (both sides of LED RetroFit).



18. Put a level on the LED Retrofit for final leveling, and adjust the cable length to level the LED RetroFit.



19. Restore the power and you're done! Enjoy your new energy saving LED Light.



RF32UHT1XX, RF45UHT1XX, RF32UQT1XXC AND RF45UQT1XXC INTERCONNECTING STANDALONE USE

▶ For interconnecting install. Do not restore power before you complete steps 1a-1c below.

1a. Place and align the second 1' x 4' LED Retrofit with the C14 socket as close to the first LED Retrofit as needed to allow use of Retrofit accessory (RFAC, RFAC-8IN or RFAC-4FT) by repeating the wire cable accessory steps 11-18 in this section.



1b. Place the Retrofit accessory (RCAC, RFAC-8IN or RFAC-4FT) to connect both the Retrofit's together.

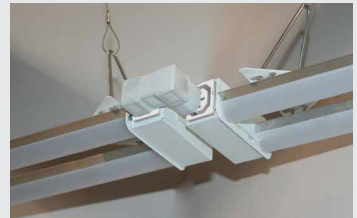

1c. Restore the power and you're done! Enjoy your new energy saving LED Retrofit



Our 1x4's can be assembled into long chains off one power source depending on Retrofit wattage. Connect retrofits when aligned together using the dual connector (RFAC). Connect retrofits together when up to 8" apart using 8in lamp to lamp extension cable (RFAC-8IN). Connect retrofits together when 8"- 4' apart using 4ft lamp to lamp extension cable (RFAC-4FT). Cables shown on page 4.

Maximum number of units by Watts

32W = 18 Retrofits

45W = 12 Retrofits

Thank you for choosing

LITETRONICS®

6969 W. 73rd Street
Bedford Park, IL 60638

WWW.LITETRONICS.COM

CustomerService@Litetronics.com or 1-800-860-3392

