



LED Round High Bay

UFO Swingline Series



UFO Swingline Series

Beyond LED Technology's New Swingline UFO High Bay is the newest and most feature rich product of 2021. Swingline is designed to maximize light output with efficacy up to 150 Lumens per Watt. Swingline is built to last with standard 4kv surge protection, 113°F ambient temperature rating, and IP65 rating for elimination of dust, moisture, and airborne contaminants. The unique easy connect driver to optical assembly interface allows for quick and easy maintenance for applications including warehousing, gymnasiums, manufacturing, and outdoor canopies. Our Swingline High Bay is fully ready to integrate with most smart control systems.

- Up to 145 Lumens per watt
- Ultra thin Sleek Design
- 0-10V Dimming capability
- Plug and Play Motion Sensor
- Several mounting options
- IP65 water, dust, corrosion, and pressure proof
- Optional Emergency backup
- Universal 100-277Vac / 480Vac optional
- DLC listed

LED Round High Bay UFO Swingline Series

UFO Swingline Series - HD High Bay Light

SKU #	Model #	Watts	Lumens	CCT	Housing Color	Input Voltage	Certifications
151774	BLT-HB08-100WRBCPD1-abcd	100W	14500Lm	5000K	White	100-277Vac	UL & DLC
151773	BLT-HB08-150WRBCPD1-abcd	150W	21750Lm	5000K	White	100-277Vac	UL & DLC
151775	BLT-HB08-240WRBCPD1-abcd	240W	34800Lm	5000K	White	100-277Vac	UL & DLC

Dimensions

Standard
Hook Mount

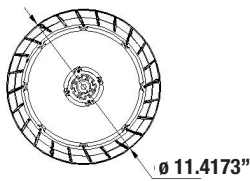

100W / 150W
Hook Mounted

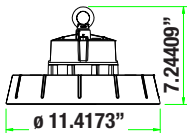

100W / 150W
Hook Mounted
with optional Motion Sensor

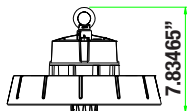

100W / 150W
Surface Mounted

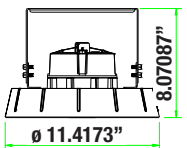

100W / 150W
Surface Mounted
with optional Motion Sensor

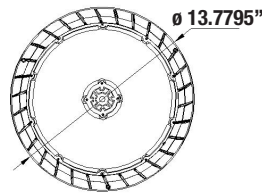
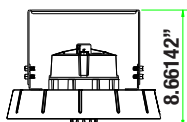

240W
Hook Mounted

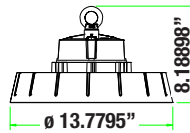

240W
Hook Mounted
with optional Motion Sensor

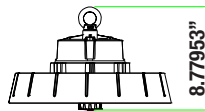

240W
Surface Mounted

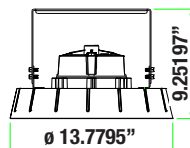

240W
Surface Mounted
with optional Motion Sensor

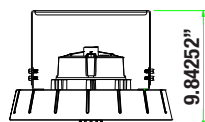

Optional Motion Sensor
SKU: 152598

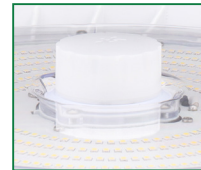

Optional Motion Sensor
Remote SKU: 152613



Optional
100W / 150W U-Bracket
SKU: 151885



Optional
200W / 240W U-Bracket
SKU: 151886



CORRELATED COLOR TEMPERATURE (CCT)

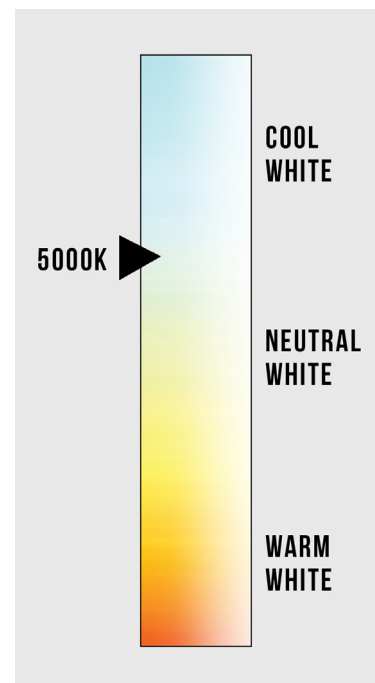

LED Round High Bay

UFO Swingline Series

100W Specifications

Color temperature	5000K
CRI	>80
Cover	Clear PC
Lumen	14500Lm
Viewing Angle	110°
Input Power	100W
Input Voltage	100-277Vac 50/60Hz
Driver Brand	(1-10V Dimming) Driver
Optional Accessory	Motion Sensor/Surge-Protective Device
PF	>0.9
Waterproof Rating	WET (IP65)

LED Type	2835 (0.5W)
LED QTY	280 PCS
Housing	Aluminum
Housing color	White
Cover	PC cover

Operating Temperature	-40°F to 131°F
Operating Humidity	10%-90% RH
Storage Temperature	-40°F to 176°F
Storage Humidity	10%-95%
Application	Indoor
Safety Certification	UL cUL
Warranty Time	5 Years



LED Round High Bay

UFO Swingline Series

100W Distribution Diagram

IES Classification: Type II
 Total Rated Lamp Lumens: 14281.9 lm
 Efficiency: 100%
 Upward Ratio: 1%
 Central Intensity: 5032.33 cd
 Pos of Max. Intensity: H90 V1

Longitudinal Classification: Very Short
 Measurement Flux: 14281.9 lm
 Downward Ratio: 99%
 Luminaire Efficacy Rating (LER): 142.92
 Max. Intensity: 5042.85 cd

Luminous Intensity Distribution Curve

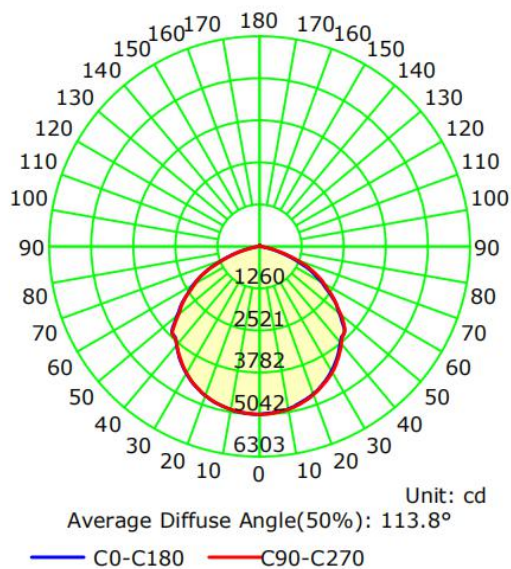

The Average Illuminance Effective Figure

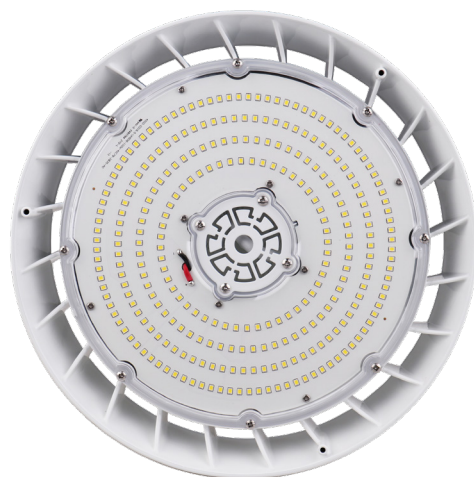
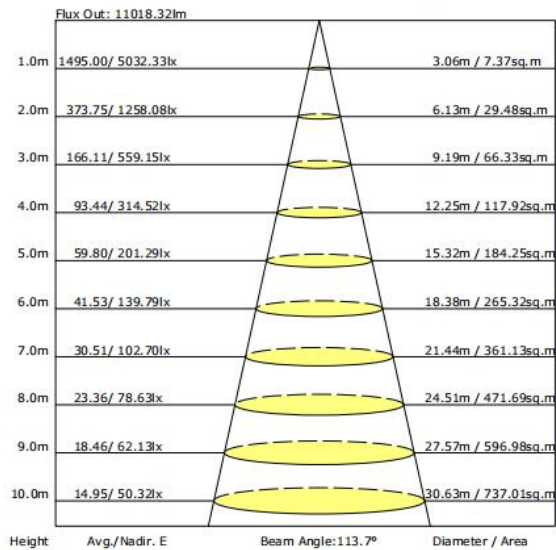

LED Round High Bay

UFO Swingline Series

150W Specifications

Color temperature	5000K
CRI	>80
Cover	Clear PC
Lumen	21750Lm
Viewing Angle	110°
Input Power	150W
Input Voltage	100-277Vac 50/60Hz
Driver Brand	(1-10V Dimming) Driver
Optional Accessory	Motion Sensor/Surge-Protective Device
PF	>0.9
Waterproof Rating	WET (IP65)

LED Type	2835 (0.5W)
LED QTY	400 PCS
Housing	Aluminum
Housing color	White
Cover	PC cover

Operating Temperature	-40°F to 122°F
Operating Humidity	10%-90% RH
Storage Temperature	-40°F to 176°F
Storage Humidity	10%-95%
Application	Indoor
Safety Certification	UL cUL
Warranty Time	5 Years



LED Round High Bay

UFO Swingline Series

150W Distribution Diagram

IES Classification: Type II
 Total Rated Lamp Lumens: 20611.3 lm
 Efficiency: 100%
 Upward Ratio: 1%
 Central Intensity: 7236.4 cd
 Pos of Max. Intensity: H270 V1

Longitudinal Classification: Very Short
 Measurement Flux: 20611.3 lm
 Downward Ratio: 99%
 Luminaire Efficacy Rating (LER): 141.55
 Max. Intensity: 7240.35 cd

Luminous Intensity Distribution Curve

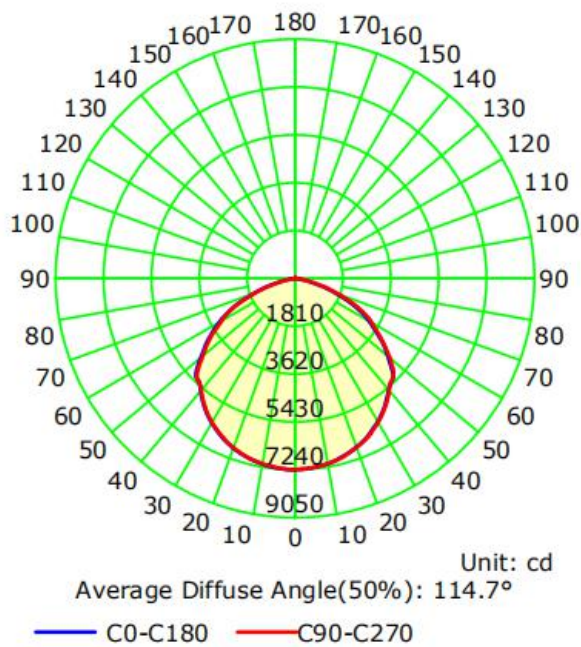

The Average Illuminance Effective Figure

Flux Out: 16088.33lm

Height	Avg./Nadir. E	Beam Angle:114.8°	Diameter / Area
1.0m	2091.31/ 7236.40lx		3.13m / 7.69sq.m
2.0m	522.83/ 1809.10lx		6.26m / 30.77sq.m
3.0m	232.37/ 804.04lx		9.39m / 69.24sq.m
4.0m	130.71/ 452.27lx		12.52m / 123.09sq.m
5.0m	83.65/ 289.46lx		15.65m / 192.32sq.m
6.0m	58.09/ 201.01lx		18.78m / 276.95sq.m
7.0m	42.68/ 147.68lx		21.91m / 376.95sq.m
8.0m	32.68/ 113.07lx		25.04m / 492.35sq.m
9.0m	25.82/ 89.34lx		28.17m / 623.13sq.m
10.0m	20.91/ 72.36lx		31.30m / 769.30sq.m

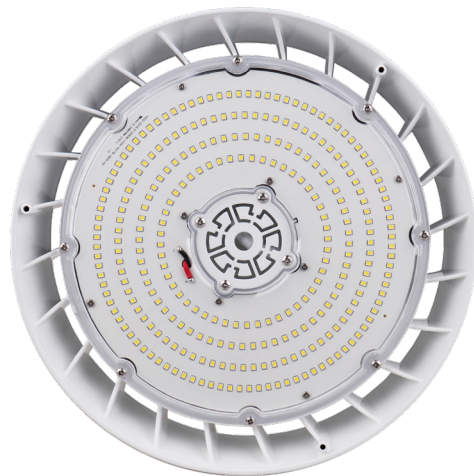

LED Round High Bay

UFO Swingline Series

240W Specifications

Color temperature	5000K
CRI	>80
Cover	Clear PC
Lumen	34800Lm
Viewing Angle	110°
Input Power	240W
Input Voltage	100-277Vac 50/60Hz
Driver Brand	(1-10V Dimming) Driver
Optional Accessory	Motion Sensor/Surge-Protective Device
PF	>0.9
Waterproof Rating	WET (IP65)

LED Type	2835 (0.5W)
LED QTY	680 PCS
Housing	Aluminum
Housing color	White
Cover	PC cover

Operating Temperature	-40°F to 122°F
Operating Humidity	10%-90% RH
Storage Temperature	-40°F to 176°F
Storage Humidity	10%-95%
Application	Indoor
Safety Certification	UL cUL
Warranty Time	5 Years



LED Round High Bay

UFO Swingline Series

240W Distribution Diagram

IES Classification: Type II
 Total Rated Lamp Lumens: 33876.0 lm
 Efficiency: 100%
 Upward Ratio: 0%
 Central Intensity: 12010.11 cd
 Pos of Max. Intensity: H22.5 V1

Longitudinal Classification: Very Short
 Measurement Flux: 33876 lm
 Downward Ratio: 100%
 Luminaire Efficacy Rating (LER): 143.51
 Max. Intensity: 12017.89 cd

Luminous Intensity Distribution Curve

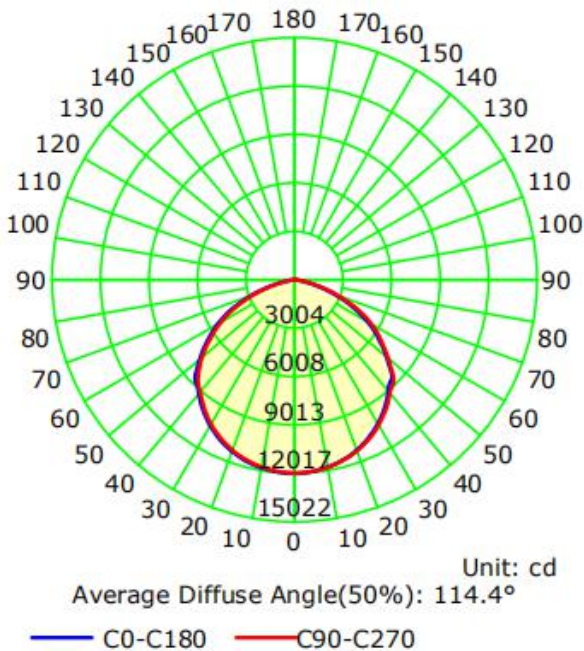

The Average Illuminance Effective Figure

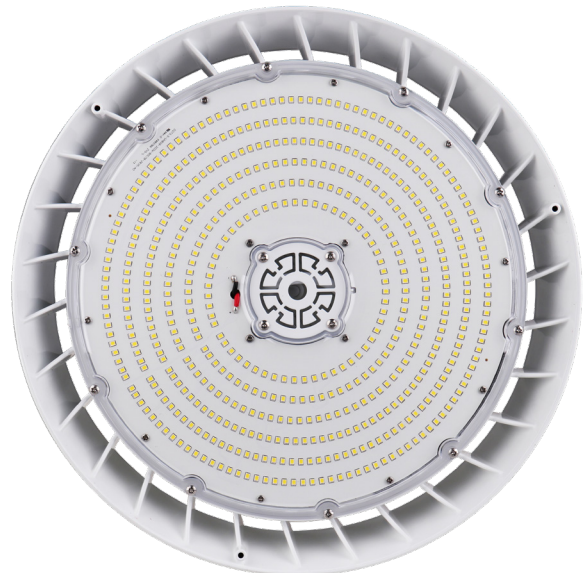
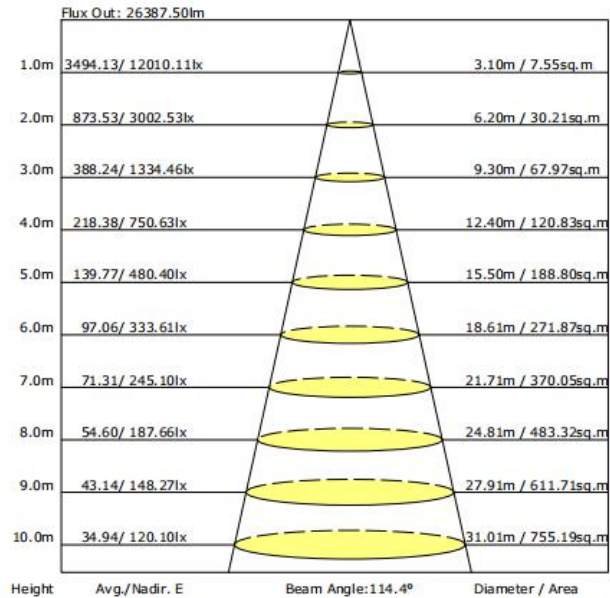

LED Round High Bay UFO Swingline Series

Installation

Cautions:

1. Can not use the electric generator to test the LED lamp.
2. Please abide by related country, regional and local law and regulations when installing this fixture.
3. Please turn off the power before installation or maintenance.
4. Proper grounding is required to ensure safety.

Notice:

1. To avoid possibility of electrical shock or fire, the installation personnel must have professional electric knowledge.
2. Please wear gloves to avoid injury before installation.
3. If any smoke or spark of the wire happens, please turn off the power immediately and notify relevant personnel.

Attention:

1. Please check if there is any damage during shipping. If so, please contact manufacturer immediately .
2. Please read the installation instruction carefully to check whether all the accessories are included. After confirmation, then install the fixture according to installation steps.

Wiring Diagram & Instruction:

This led high bay light can be equipped with optional DC motion sensor, and is available with 1-10V dimming function, with following 3 dimming solutions:

1. 1-10V dimming,
2. Intelligent dimming with DC motion sensor,
3. Pre-install tool-free handling DC motion sensor dimming module, and choose dimming function freely.
4. According to different product models, there are two different cases that DC12V wire and DIM wire may have three or four cores. Please refer to Figure A for the specific wiring method.

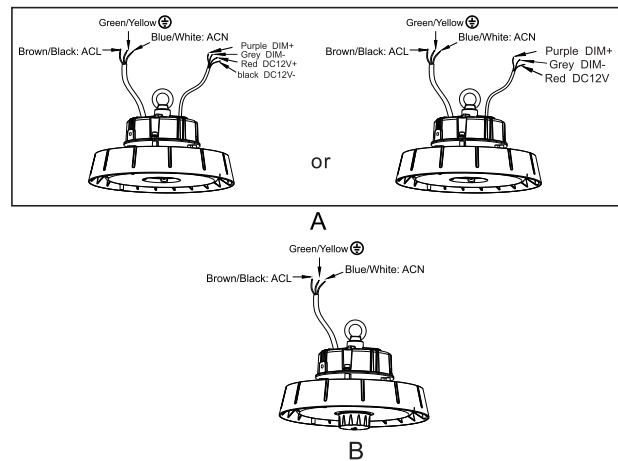

Installation Methods: Hook Mount, Ceiling Mount, 1/2"NPT Mount. (Please choose the most suitable installation method for the purchased product as per your needs)

Hook Mount:

1. Screw the hook into the fixture, and tighten. (figure 1)
2. Hang the fixture on the ceiling hook or chain. (figure 2)
3. After installation, connect the wire of the fixture to the mains according to local wiring rules, ensure the connection is stable and make good protection on the connection.

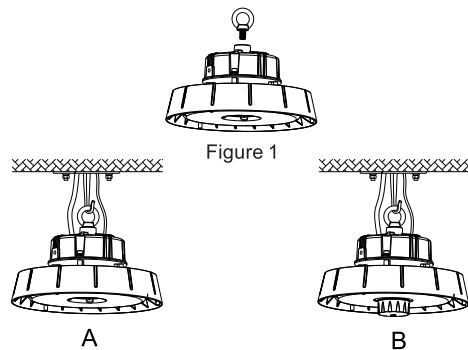

Figure 2

LED Round High Bay UFO Swingline Series

Installation

Ceiling Mount:

1. Mark with a mark pen or sharp tool on the mounting surface and drill. (figure 3)
2. Fix screws into the holes with a or drill. (figure 4)
3. Align the bracket hole with screw hole (figure 5), and push the fixture to one side (figure 6) and secure it.
4. After installation, connect the wire of the fixture to the mains according to local wiring rules, ensure the connection is stable and make good protection on the connection. By adjusting the brackets screws, users can adjust 50° to the left or right vertically. (figure 7)

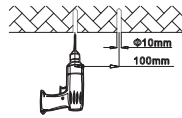

Figure 3

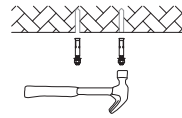

Figure 4

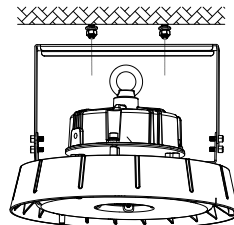

Figure 5

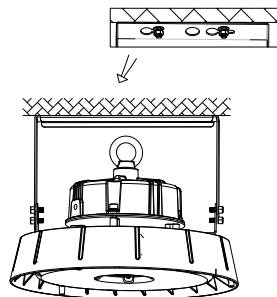

Figure 6

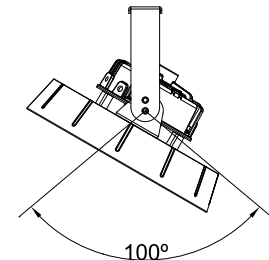

Figure 7

1/2"NPT Mount

1. Unscrew the nuts on 1/2" NTP. (figure 8)
2. Insert 1/2" NTP stem into the bracket hole. (figure 9)
3. Re-screw the nuts. (figure 10)
4. After installation, connect the wire of the fixture to the mains according to local wiring rules, ensure the connection is stable and make good protection on the connection. By adjusting the brackets screws, users can adjust 50° to the left or right vertically. (figure 11)

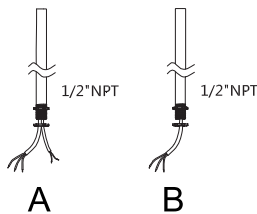

Figure 8

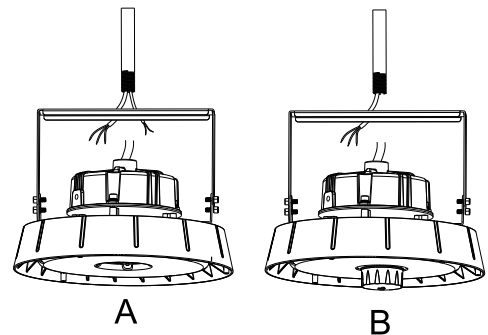

Figure 9

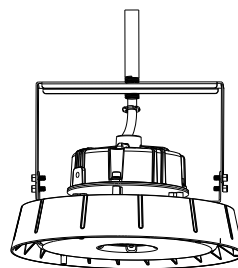

Figure 10

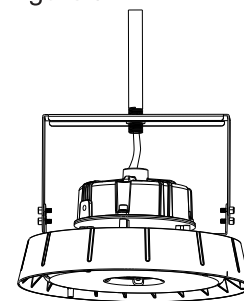

Figure 11

LED Round High Bay UFO Swingline Series

Installation

Installation of DC motion sensor

It could be easily installed without using any tools. Choose whether to install the motion sensor or not as per your demand (figure 12); if not, unscrew the motion sensor and replace it with a protection cover, and vice versa.
Note: the motion sensor has no dialing code, and a remote control is needed for adjustment. Please refer to the instruction for remote control adjustment.

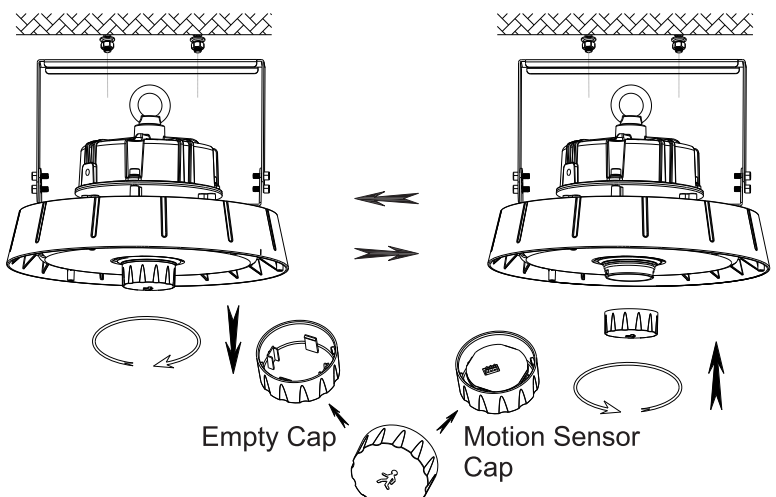

Figure 12



100W / 150W
Hook Mounted with optional Motion Sensor



240W
Hook Mounted with optional Motion Sensor

Motion Sensor Specifications - SKU 152598

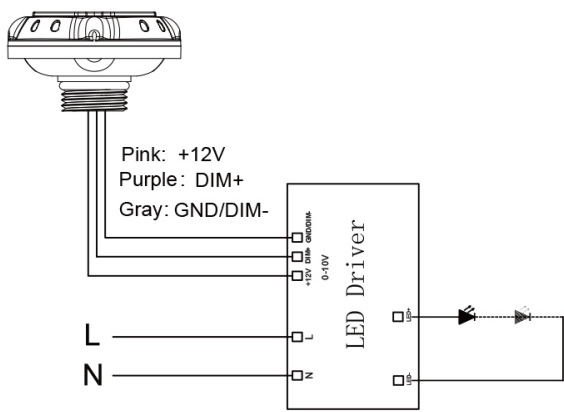

Wiring diagram

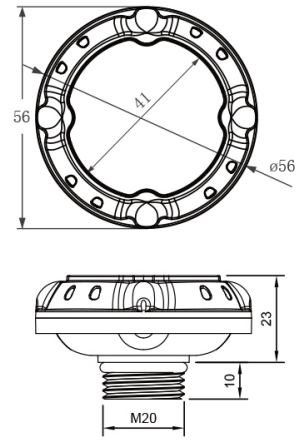

Unit:mm

LED Round High Bay UFO Swingline Series

Motion Sensor Specifications - SKU 152598



On/off control



Stand-by dimming level



Detection area



Remote control setting



Hold time



10-15M Highbay altitude



Daylight sensor



5 years warranty



Stand-by period

01 Technical data

Operating voltage	12±2V DC
Operating current	30mA
Output	DIM 0-10V
Stand-by power	<0.5W
Brightness	70%/80%/90%/100%
Sensitivity	20%/50%/75%/100%
Hold time	10s/1min/10min/30min
Daylight threshold	10Lux/30Lux/50Lux/100Lux/Disable
Stand-by time	1min/30min/60min/+∞
Stand-by dimming level	10%/20%/30%/50%
Microwave frequency	5.8GHz±75MHz
Microwave power	<0.5mW
Detection angle	30-150°
Control line	Pink:+12V; Purple:DIM+; Gray:GND/DIM-
Mounting height	Max. 15m (ceiling mounted)
Detection range	Max. 0.15m (ceiling mounted) Max. 20m (wall mounted)
Operating temperature	-30° C~+60° C
IP rating	IP65

Optional Motion Sensor Bracket SKU: 152612



Optional Motion Sensor SKU: 152598



(866) 786-1117 • www.BeyondLEDTechnology.com

Due to continuous product improvement, information in this document is subject to change.

LED Round High Bay UFO Swingline Series

Motion Sensor Specifications - SKU 152598

02 Detection coverage

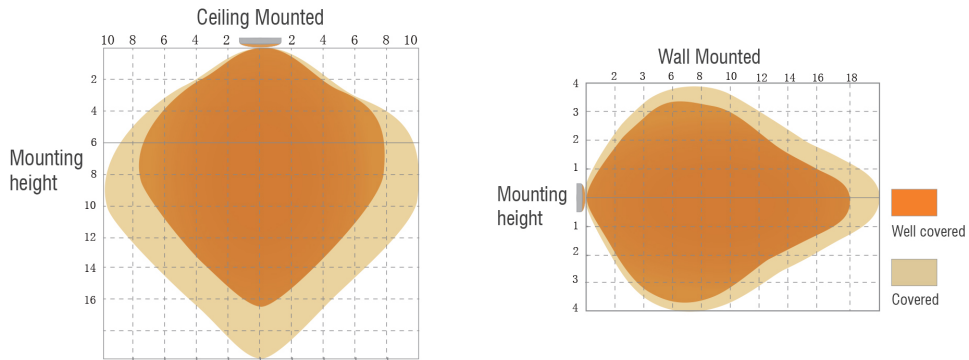

03 Lux on/off

Adopted dual PD technology, HB01DMS-A/B is able to differentiate artificial light brightness from natural light after installed inside the fixture, and automatically turn off light when ambient brightness exceeds preset lux level.

Preconditions to use the Lux-off function:

1. Stand-by period is $+\infty$;
2. Stand-by dimming level is on 10%, 20%, 30% or 50%;
3. Daylight threshold is on 10Lux, 30Lux, 50Lux or 100Lux.

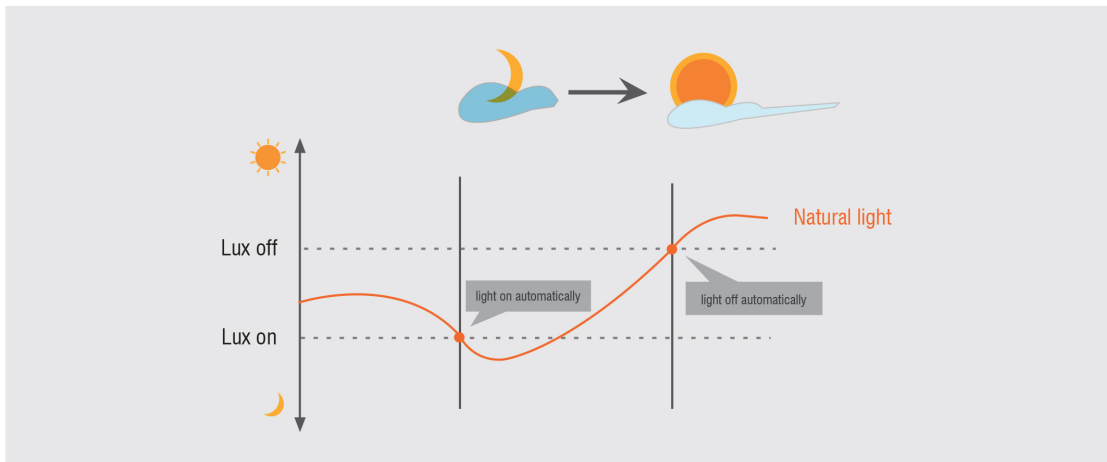

04 Application—Lux on/off

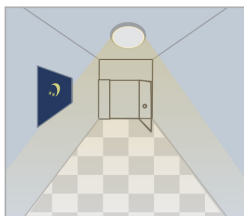
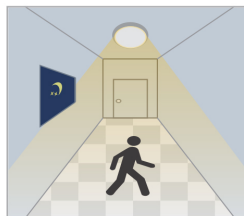
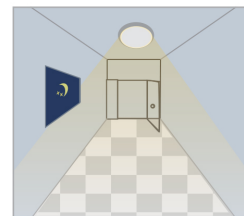
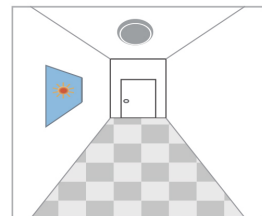
			
<p>Light automatically on when ambient brightness is lower than preset lux level.</p>	<p>With insufficient ambient brightness, light dims to 100% when motion detected.</p>	<p>Light dims to stand-by level if no motion detected after hold time.</p>	<p>Light off when ambient lux level is higher than preset lux amount.</p>

LED Round High Bay UFO Swingline Series

Motion Sensor Remote Control Specifications - SKU 152613

HB03R

Remote for dimmable sensors

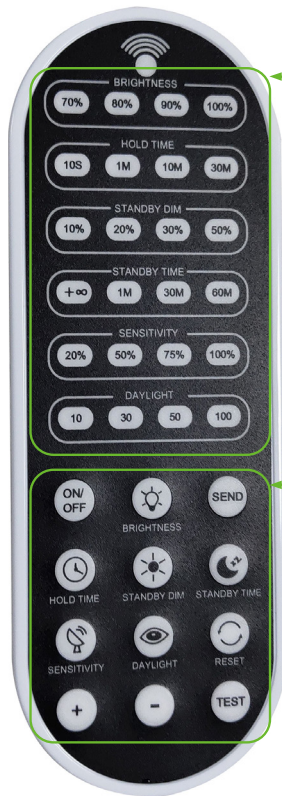

Display Area

BRIGHTNESS (70%/80%/90%/100%)
DAYLIGHT (10lx/30lx/50lx/100lx)
STANDBY DIM (10%/20%/30%/50%)

HOLD TIME (10S/1min/10min/30min)
SENSITIVITY (20%/50%/75%/100%)
STANDBY TIME (+∞ /1min/30min/60min)

Button Setting Area

- ON/OFF** (Long press the "ON/OFF" button until the brightness indicator light is on(First-row),Press to turn on or turn off the fixture.)
- BRIGHTNESS** (Press to adjust dimming level 70%/80%/90%/100%.)
- SEND** (Press to save settings after each change,The indicator light confirms the save setting.)
- HOLD TIME** (Press to adjust hold time 10s/1min/10min/30min.)
- DAYLIGHT** (Long press the button until the daylight indicator light is on,press to adjust daylight threshold 10lx/30lx/50lx/100lx.)
- SENSITIVITY** (Press to adjust sensitivity 20%/50%/75%/100%.) Note: PIR Motion Sensor have no sensitivity setting,the default 100%.
- STANDBY DIM** (Press to adjust stand-by dimming level 10%/20%/30%/50%.)
- STANDBY TIME** (Press to adjust stand-by time +∞ /1min/30min/60min.)
 Note: "+∞" means unlimited stand-by time,and the light control mode is the light control priority mode, otherwise it's the light threshold mode.
- RESET**
 Press "RESET"button,products with DIP switch will be controlled by DIP switches;Otherwise all the setting will change,which is Brightness 70%/ Hold time 10s/ Sensitivity 20%/ Daylight threshold disable/Stand-by dimming level 10% / Stand-by time+∞.
- TEST**
 The button "TEST" is for testing purpose after debugging,Pressing this button,the sensor goes to test mode(hold time is only 3s).
- +** Press to increase brightness(0-100%).
- Press to reduce brightness(100%-0%).

Attention

1. If you want to send a setting,it will only work if the remote control is on.If you don't press any button within 10 seconds,the indicator light will go out.
2. When using "ON/OFF"button,the rest buttons except the "ON/OFF","BRIGHTNESS"and"SEND"buttons will be disabled.
3. When using "TEST"button,the rest buttons except the "TEST","SENSITIVITY"and "SEND"buttons will be disabled.
4. Every change needs to press "SEND" button,it will be saved.
5. Because of the power supply DIMMING ratio difference, when using different power, "BRIGHTNESS" and "STANDBY DIM" adjust percentage of the power will have difference with the measured power.
6. Light control priority mode: the on/off illumination values of each gear are 10lx/50lx, 30lx/100lx, 50lx/150lx and 100lx/200lx.
7. Light threshold mode:the on/off illumination values of each gear is 10lx/30lx/50lx/100lx , when the light intensity is less than set value and the movement of someone or an object is induced, the light is turned on to the preset brightness.

LED Round High Bay

UFO Swingline Series

Packing

SKU #	Type	Pcs/Box	Dimensions	Weight	Pallet Quantity	Pallet Weight	Pallet Dimensions
151774	UFO	1	14" X 14" X 8"	9 Lb			
151773	UFO	1	14" X 14" X 8"	9 Lb			
151775	UFO	1	16" X 16" X 9"	12 Lb			

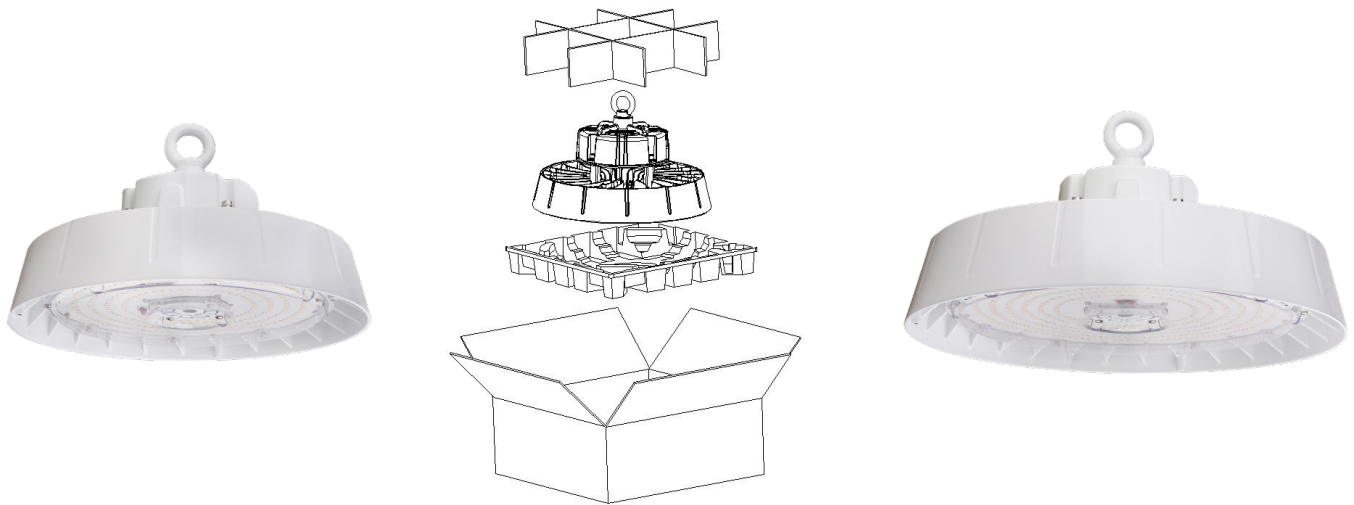

User Notice

- Please turn off the power before installing or changing assembly parts.
- The input voltage and lamps should be matching. Before connecting the power line, please make sure the wiring section is insulated.
- Only professionals should install and disassemble the lamps.

Trouble Shooting

- Flickering light - Turn off the power and turn on again in 3 minutes. If the same phenomena occurs, then call Support.
- Not working - Please check all power connections.

LED Round High Bay

UFO Swingline Series

Application

